



Leading Technology Partners.....

BssTech

بن ساري للتقنية المتخصصة
متخصصون في أعمال التحكم في الصدأ والتآكل والوقاية الكاثودية



B.S.S. Technologies

Specialized in Corrosion Control & Cathodic Protection

A SAIT GROUP COMPANY

Cathodic Protection, Anti Fouling, AC Mitigation, Corrosion Engineering, Gas Flow Measurement & Regulation, Construction & Manufacturing, Pipeline Information Management System, Leak Detection, Coatings & Field Joints, Insulation Joints, Wireless Remote Monitoring Systems, Well Head Monitoring System, Downhole Monitoring System, Pumping Solutions, High Voltage Cables, Composite Repair Materials, Electric Heat Tracer.....

www.bsstechnologies.com

1119R11

Your True Partner for Asset Integrity Management



A SAIT GROUP COMPANY

SAIT GROUP, one of the world class group companies and pioneers in the middle east specialized in Cathodic Protection and Corrosion Engineering. Since inception, it has become the leading solution providers in MENA and Asia Pacific. Over the last 20 years, the group has developed a highly resourced, responsive global company with strategically positioned offices and facilities in Abu Dhabi, Dubai, Saudi Arabia, Kuwait, India, Malaysia, Nigeria, Canada. The group has its state of art manufacturing units in Dubai, Malaysia & India. The Production facility operates with state of the art technologies and equipment with the layout to address the quality, safety and environment requirements. With over 300 employees worldwide, we are committed to customer satisfaction through continuous training, research & development and improvement of our qualified trained technical and non-technical staff.

IN LAST TEN YEARS GROUP HAS FOCUSED IN DIVERSIFYING BY PARTNERING WITH LEADING INTERNATIONAL COMPANIES WHO HAS THE CAPABILITIES IN PROVIDING PRODUCTS AND SERVICES IN RELATED INDUSTRIES SERVING ASSET MANAGEMENT AND ASSET INTEGRITY AND OTHER RELATED SERVICES TO STRENGTHEN THE SUPPLY CHAIN.

WE ARE "ONE STOP CONSULTING / ENGINEERING / MATERIAL / EQUIPMENT PROVIDERS AND CONTRACTORS FOR THE WIDE VARIETY OF REQUIREMENTS IN INTEGRITY MANAGEMENT IN THE OIL, GAS, WATER, ENERGY, TRANSPORT AND INFRASTRUCTURE SECTOR."

BSS Technologies, the backbone of Sait Group is based out of Abu Dhabi with capabilities in Cathodic Protection and Corrosion Engineering, it has developed own subsidiaries in manufacturing and has capabilities in surveys, engineering, R & D, installation, construction and maintenance.

Bin Sari Metal Casting, our manufacturing unit specialized in the manufacturing of Sacrificial Anodes, Transformer Rectifier Units, Remote Monitoring and Control systems, is located at National Industries Park, Jebel Ali – Dubai. We do keep stock of all major materials required in the field of Cathodic Protection and Corrosion Engineering. Major supply includes Transformer Rectifiers, Solar Power Systems, Sacrificial Anodes, Impressed Current Anodes, RMCS, Cables, Test Stations, Junction Boxes, Corrosion Coupons, Corrosion Monitoring probes, Backfill materials..etc

SSEC, Sait Specialized Engineering and Contracting is based in Abu Dhabi and serving the industry with their expertise in Electro Mechanical and Civil contracting. The primary objective which paved the birth of this organization was to cater the inhouse business subcontract activities of Sait group of Companies. Gradually it became an independent organization encouraged by the opportunities outside the group business. The diversity of our project experience enables us to match our services closely to the needs of each of our clients. This organization created inhouse capability in installation of CP system.

RACE Tech, is the RESEARCH & DEVELOPMENT division of BSS Technologies located at Mumbai - India. It is SAIT Group management's special interest that a good percentage of our annual profit is wisely invested in the areas of Researches in Electronics and Softwares in developing new products. These are spent either directly in our facilities or in close co-operation with our raw material supplier's facilities. A wide variety of designs are developed inhouse and selected to customer satisfaction, strictly in accordance with the quality standards, environmental conditions and material standards. New technologies are selected with thorough knowledge and fully understanding the properties and behavior of the products

KAZ, the Division of SAIT Group established in the Kingdom of Saudi Arabia to cater to specialized Engineering Services of Sait Group in the Saudi Region. It also has a manufacturing facility in Jubail. Apart from offering specialized Cathodic Protection and Corrosion Engineering services, it also act as a satellite office of all the subsidiaries of SAIT Group and promote all capabilities of the group in its region.

SSE Technologies, Sait Specialized Engineering Technologies Kuwait W.L.L is an independent arm of SAIT Group, to cater to the ever increasing corrosion control needs of the Oil & Gas, Electricity, Water, Marine & Construction industry in Kuwait. Apart from offering specialized Cathodic Protection and Corrosion Engineering services, it also act as a satellite office of all the subsidiaries of SAIT Group and promote all capabilities of the group in its region.

BSS Technologies CP (INTL) SDN. BHD, Malaysian Manufacturing and Services Hub for Malaysia, Indonesia, Singapore, Australia. Apart from offering specialized Cathodic Protection and Corrosion Engineering services, it also act as a satellite office of all the subsidiaries of SAIT Group and promote all capabilities of the group in its region.

BSS Tech CP (I) PVT LTD will handle as a dedicated team, the increasing demand in India in the field of Cathodic Protection & Corrosion Engineering. Apart from offering specialized Cathodic Protection and Corrosion Engineering services, it also act as a satellite office of all the subsidiaries of SAIT Group and promote all capabilities of the group in its region.

Sait Group of Companies



Specialized in Corrosion Control & Cathodic Protection



Manufacturers of Cathodic Protection Materials & Equipments



Specialized Equipment Trading and Electromechanical Installation & Inspection Services



Power Electronics R&D, Remote Monitoring and Control System, Software Development



Cathodic Protection & Corrosion Engineering Services. Specialized Equipment trading & Inspection Services



Cathodic Protection & Corrosion Engineering Services. Specialized Equipment trading & Inspection Services



CP (I) PVT LTD Specialized in Corrosion Control & Cathodic Protection



CP (INTL) SDN. BHD Malaysian Manufacturing and Services Hub for Malaysia, Indonesia, Singapore, Australia.



NIGERIA Specialized in Corrosion Control & Cathodic Protection

Message From the Management

BSS Technologies is privileged to be the pioneers in the corrosion engineering and cathodic protection industry in the Middle East with our skilled personnel and Research & Development Department.



INTRODUCTION TO BSS TECHNOLOGIES

BSS Technologies core competency is in the field of Corrosion Engineering and Cathodic Protection. Since inception, we have consistently followed a growth path owing to our philosophy of High-Tech Engineering Technologies with constant product innovation and upgradation.

Our primary focus has been on Customer Delight - brought about, by a rich task force of qualified, committed and experienced professionals to cater to the changing needs of the industry.

To meet our Customer requirements - we have placed our Corporate Office in Abu Dhabi- UAE. In order to provide reliable products expediently to our customers, we hold our Head Office, Engineering and Manufacturing Facilities in National Industries Park, Jebel Ali, Dubai, UAE. This facility has Transformer Rectifier production, RMCS manufacturing, Anode casting and all customisation capabilities. These Production Facilities operate with state of the art Technologies & Equipment and have the layout to address the Quality, Safety and Environmental Requirements.

Our ISO -9001:2015 certification affirms our highest commitment to our motto that **“The key to Customer Delight is quality”**

As years passed by, we diversified our business in to other fields of **Asset Integrity & Value Engineering** including **Leak Detection Systems, Coatings and Tapes, Pipeline Information Management Solutions (PIMS)** maintaining our consistent and reliable expertise for services in **Cathodic Protection and Corrosion Engineering**. We are now a **“ One Stop destination for Consulting / Engineering / Material / Equipment Providers and Contractors for the wide variety of requirements in Integrity Management in the Oil, Gas, Water, Energy, Transport and Infrastructure Sector.”**

PROFILE

BSS Tech - as a pioneer company specialized in the areas of Cathodic Protection & Corrosion Control - is a technology driven, customer oriented company. We maintain a team of qualified Engineers and Technicians with ample site experience in different countries and environments - headed by NACE CP Specialists. BSS Tech offers full range of Engineering Services, Instruments and Products related to Corrosion Engineering, Cathodic Protection, AC mitigation, Anti Fouling, apart from the core corrosion protection we also provide PIMS, Leak Detection System, Pipeline Coating & Steel Joint Coatings, Wireless Remote Monitoring Systems to the Industry in accordance with international standards. BSS Tech is a 100% self reliant organization with complete Engineering, Material and Execution capabilities with a separate Team for Surveys and Studies.

QUALITY POLICY

BSS Tech's Management Team is committed to establish, document, implement and practice a scalable Quality Management System to effectively manage Global Business Operations. Quality Performance is a commitment to excellence by BSS Tech employee and achieves it by teamwork and process of continuous improvement. We are dedicated to become the leaders in delivering quality products and services which meets or exceeds the expectations of our valued Customers. The Quality Management System gives the Organization a focal point for promoting best practices and continuous improvement in accordance with BSS Tech's Quality Policy.

TRANSFORMER RECTIFIER

Application

The Key to any impressed Current Cathodic Protection System is an efficient and reliable Power Unit that can provide an uninterrupted Direct Power Supply for the Anode Energization. BSS Tech offers a fully comprehensive range of Transformer Rectifiers including ATEX certified units.

We manufacture all types, all sized, standard, customized Transformer Rectifiers. We also manufacture explosion proof units with ATEX  certification.

Our Cathodic Protection Engineers are available to advice the most efficient & economical Transformer Rectifier units for any specific application.

How to Order

To help our clients to pick the best features in a Transformer Rectifier unit, BSS Tech had developed an easy procedure. Pick the features from the following. A sample order can be explained as below:

BSTR-48-100-A-1-A-A-O-S-BIS The Order Code is supplied with the below reference:

SAMPLE CODE	BS	TR	48	100	A	1	A	A	O	S	BIS
REFERENCE	1	2	3	4	5	6	7	8	9	10	11

Reference Detail:

- | | | |
|-------------------|----------------------------------|--------------------------|
| 1) BS | 6) Input Power Frequency : | 10) Enclosure Type: |
| 2) TR | 1) 50 Hz | H - Hazardous Area Use |
| 3) DC volt* | 2) 60 Hz | I - Safe Area Indoor |
| 4) DC amp* | 7) Mode of Operation: | S - Safe Area Outdoor |
| 5) AC Input: | A - Auto | X - ATEX certified |
| A - 415V, 3Ph | B - Manual | 11) Special Features: |
| B - 400V, 3Ph | 8) Type of Control: | T - Timer |
| C - 115/240V, 1Ph | V - Variac Control | F - DC Fuse Alarm |
| D - 240/460, 1Ph | T - Thyristor Control | O - 115V Outle |
| E - 240/260, 3Ph | A - Tap Changer | B - Breather |
| F - 240V, 1Ph | 9) Cooling: | D - Dual Inlet |
| G - 115/480, 1Ph | O - Oil Cooled | I - Current Interrrupter |
| H - 120 V ,1Ph | A - Air Cooled | S - Surge Arrester |
| | E - Oil Immersed Explosion Proof | R - Remote Control |
| | | M - Multi-Channel* |
| | | N - Remote Monitoring |
| | | A - Auto Change over |

* For Multi-Channel Transformers, Reference No. 3 & 4 shall be indicated as V & I respectively. The details of the channel voltage & Current shall be provided seperately while ordering the Transformer Rectifier.

TRANSFORMER RECTIFIER



- Air Cooled
- Oil Immersed
- Explosion Proof
- Special Purpose
- Custom Design
- **ATEX certified**

Standard Rating TR units

10V, 10A	20V, 15A	20V, 20A	25V, 15A	25V, 25A
25V, 50A	50V, 50A	50V, 75A	75V, 75A	100V, 100A

REMOTE MONITORING & CONTROL SYSTEM

CATS-EYE™



**Your eyes to
Cathodic Protection System**

HARDWARE

CP RMU can be integrated with any existing CP power supply to collect and deliver the prescribed parameters to the base. CP RMU can be used as a replacement to any test station.



REMOTE MONITORING & CONTROL SYSTEM

Application

The Remote Monitoring and Control System (RMCS) is designed to monitor and control Impressed Current Cathodic Protection System Remotely. RMCS helps you to accomplish complete control of the Cathodic Protection operation in a plant, in desert or in deep sea. Features RMCS consists of its own power supply units, software, communication and hardware for control monitoring & data logging. The site based equipment has local data logging facility which works on the embedded software and instructs the logic for monitoring and / or control. Power supply unit and the rest of the hardwares are placed in an instrument box or in a cabinet. The inbuilt hardware controls power supply output, communicate with remote PC in control room through radio communication which has zero operation/service charges by any third party. The software in Remote Computer communicates with RTU for Control, Monitoring and Data logging. It provides access to all functions of the RTU and a user-friendly interface with graphics. Major Monitoring and Controls available with RMCS are :

- ▶ Auto Reference Mode
- ▶ Interruption Cycle
- ▶ Site Programming
- ▶ Alarms and call back
- ▶ Data Recording
- ▶ Analytical Data Interpretation
- ▶ Graphical Report Generator
- ▶ Real Time Monitoring
- ▶ Reference Potential Monitoring & Control
- ▶ Reference, DC Voltage, DC Current monitoring and control
- ▶ SMS based alert system

Environmental Conditions

Ambient Temp	-10°C to 60°C
Storage Temp	-10°C to 60°C
Humidity	5 to 95%
Size	Customized

Electrical Interface

Input Voltage	230VAC
Surge Protection	Yes
Circuit Protection	Optical Isolation

Communication Interface **

Communication Protocol	Standard Modbus RTU
Wireless	Yes
Frequency	2.4 GHz
Optical Interfacing	Yes
TCP/IP	Yes
Ethernet Topology	Yes
GSM	Yes

** All other modes of communication like RS485, fibre optic and radio are available. Requirement used to be specified.

Real Time Voltage, Current, Reference Monitoring

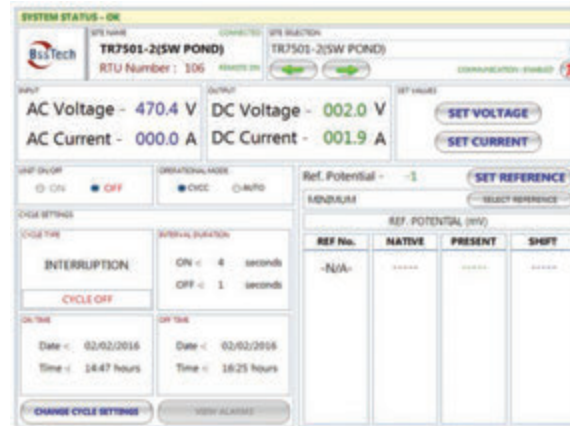

Report Generator & Data Recording

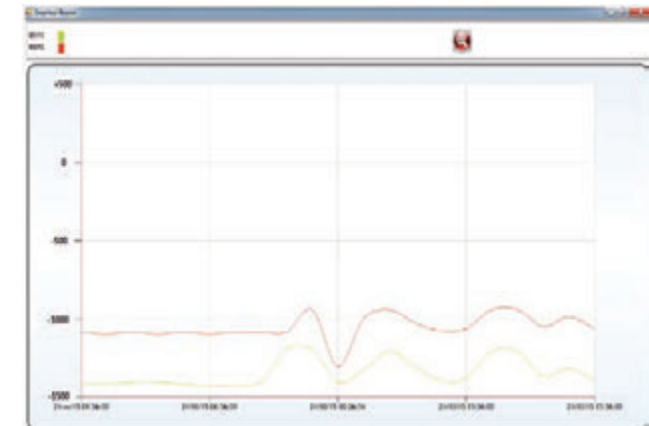

SAIT™ - CPDM

The application named – “SAIT™- CPDM” is GEI enabled CP infrastructure life cycle monitoring. Database application software is developed with Java Virtual machine, Data Server and Application server. The primary aspect of this software is to collect, store, safeguard the cathodic protection data and its asset details and provide custom made reports to evaluate the protection of various assets. The software provides unique facility to customize and store the entire cathodic protection components and structures. The software is compatible with all Windows platform. The Software is available as ‘Single User’, ‘Server Based’ and ‘Web Based’ - which makes ‘SAIT-CPDM’ the most flexible CP Data management software catering the needs of various industries from an individual user to multiple users in big operating industry. The key feature of this software is the GIS Viewer, which allows the user to view the respective locations of all their installation and CP Components.

GIS facilitate application in:

- Monitoring assets conditions to assist in infrastructure life cycle planning and replacement.
- Field crews can capture inspection information and quickly update centrally stored as-built in data.
- Engineers can monitor cathodic protection systems to view information in relation to the distribution system, diagnose problems, and ensure corrosion protection.

System Overview:

- The system involves developing a "WEB Desktop GIS*" based system by incorporating geographical database with real pipeline data consisting of rail/road/foreign pipeline crossings, CP locations, valve locations, etc. with facility of user-friendly retrieval of information.

Key functionality allows the user to:

- 100% Compatible with any structure or Installations.
- 100% Customizable to any kind of CP Systems
- Historic data collection & analysis ; GIS Compatibility
- Map showing actual location of all structures and CP Components
- Back up & Restore feature; Expandable to any number of fields
- High Security

*WEB Desktop GIS - A web desktop or webtop is a desktop environment embedded in a web browser or similar client application. A webtop integrates web applications, web services, and applications on the local client into a desktop environment using the desktop metaphor.

Features & Benefits

Features	Benefits
Flexible data entry and adhoc reporting	Search, sort, and analyze data quickly
Year-to-year comparisons of various CP segments	Easy visualization of problem areas with graphical reports
Manage large quantities of data on asset types and other related maintenance information	See problem areas for test stations, rectifiers, galvanic anodes, foreign bonds, isolated services, tank performance, and hundreds of pipeline assets
User-configured hierarchical tree for organization and editing	Advanced organization and efficient editing for workflow
Multi-user design for replication and synchronization	Share critical data throughout an organization
Comparative line graphs, individual test point, rectifier and bond graphs, and continuous strip charts	Analyze distribution and transmission lines
Backup databas	Restore database

SAIT™ - CPDM

Software for Asset Integrity Techniques
- CP DATA MANAGER

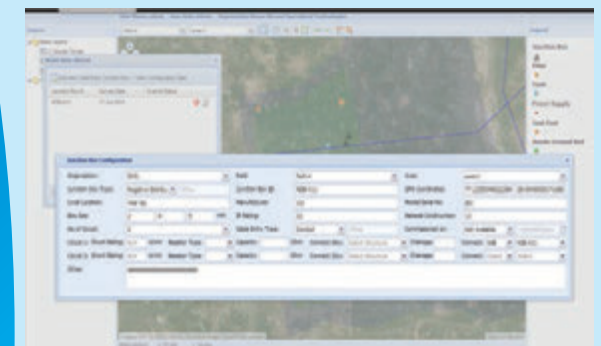

*An indispensable tool for
Cathodic Protection professionals*

- Manages multiple facility types and surveys
- Schedules routine field data collection
- Judges system effectiveness
- Pinpoints problems
- Prepares operators for regulatory audits

C P MONITORING SYSTEM



Test Station - Captain

TEST STATION - CAPTAIN

Information

BSS Tech introduces an innovative, economical and versatile solution for Cathodic Monitoring on Buried Metallic Structures, CAPTAIN – Cathodic Protection Test Stations have been specially developed for Monitoring of Cathodic Protection Systems.

CAPTAIN is a High Impact Resistant, Non Conductive, above Ground Terminal for conveniently Monitoring Electrical Currents & Potentials associated with all type of Cathodically Protected Structures.

CAPTAIN can be used as Monitoring Stations as well as Junction Boxes. Major applications are as listed below:

- 1) Underground Structure Potential Monitoring as a Test Station
- 2) Junction Box for Anodes; especially for Sacrificial Anodes
- 3) Reference Electrode Junction Box
- 4) Pipeline Bonding Stations for Crossing & Parallelism
- 5) Grounding System Termination

Technical Features

- 1) Produced from High Impact Polycarbonate; One of the World's toughest Plastic which is used in making Aircraft Windows, all kind of helmets from Military to Sports to Crash Helmets, etc.
- 2) Has 4 times the Impact strength of Aluminium with one half its weight.
- 3) Maintains Dimensional & Electrical stability in Temperature range from -60°F to +250°F.
- 4) Remains Stable under Ultra Violet Rays.
- 5) Terminals completely accessible from both side of Terminal Board.
- 6) Polycarbonate being Non Metallic & extremely resistant, reduces Electrical Shock Hazards drastically.
- 7) Available in wide range of colours to suit User Preferences.

Materials used

Test Station: Polycarbonate

Hardware: Machined Screws, Washers & Hex Nuts
(All Stainless Steel)

Conduit (Optional): Ultra Violet Stabilized



Each Test Station consists of a Cover, a Terminal Board with Integral Compression - Fit Base & a Compression Nut for Clamping the Base to the Conduit & other Accessories.

SACRIFICIAL ALUMINIUM ANODE

Information

Aluminium Anodes are usually applied in Water, Sea Water or Produced Brines. Standard Aluminium Anodes are supplied in variety of Sizes and Weights. Prolonged exposure above 122°F will result in excessive Consumption of Anode Material.

Aluminium Alloys

Elements	Mil –A-24779	DNV RP B401	GALVALUM III
Silicon	0.08 – 0.20	0.12 max	0.08 – 0.20
Iron	0.09 max	0.09 max	0.13 max
Zinc	4.0 – 6.5	2.5 – 5.75	2 - 6
Indium	0.014 -0.020	0.015 – 0.040	0.01 – 0.02
Copper	0.004 max	0.003 max	0.006 max
Others(each)	0.02 max	0.02 max	0.02 max
Aluminium	Remainder	Remainder	Remainder

Weld on - Tear Drop

Anode Type(New)	Anode Dimensions(mm)			Core Dimensions(mm)			Weight (kg)	
	Length	Width	Height	Length	Width	Height	Net wt.	Gross Wt.
BTA005T	120	40	25	200	10	3	0.2	0.25
BTA011T	180	60	32	260	20	3	0.4	0.5
BTA020T	220	75	38	300	20	3	0.8	0.9
BTA031T	200	95	30	300	20	3	1.2	1.4

Weld on - Double Strap

Anode Type	Anode Dimensions(mm)			Core Dimensions(mm)			Weight (kg)	
	Length	Width	Height	Length	Width	Height	Net wt.	Gross Wt.
BTA100D	305	152	36	254	32	5	3.8	4.5
BTA177D	305	152	64	254	32	5	7.4	8
BTA322D	460	230	51	430	32	6	13.5	14.5

Bolt on Type

Anode Type	Length(mm)	Width(mm)	Height(mm)	C-C(mm)	Plate Width(mm)	Plate Thickness(mm)	Net Wt.(Kg)	Gross Wt.(Kg)
BTA040B	200	100	30	110	50	5	1.4	1.8
BTA046B	200	100	40	110	50	5	1.7	2.1
BTA071B	300	150	25	160	75	5	2.8	3.2
BTA082B	300	150	30	160	75	5	3.3	3.7
BTA113B	300	150	40	160	75	5	4.7	5.1
BTA128B	300	150	50	160	75	5	5.4	5.8
BTA133B	300	200	40	160	100	5	5.6	6
BTA237B	300	200	65	160	100	5	10.3	10.7
BTA297B	400	180	70	180	80	5	13.1	13.4
BTA344B	540	200	65	340	100	5	15.1	15.5

Electrochemical Properties :

- Solution Potential: -1.1V w.r.t Ag/AgCl
- Capacity: 2500 Ah/kg (min)
- Density: 2750 kg/m³

Customized Alloy, Dimensions and shape can be produced against order

SACRIFICIAL ALUMINIUM ANODE

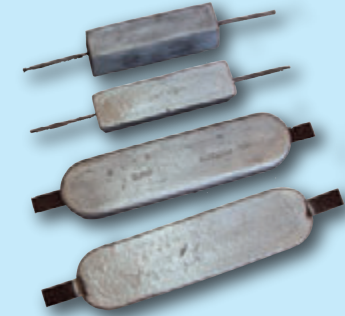

Aluminium Anode



Bracelet Anode

- Tear Drop Anodes
- Stand OFF Anodes
- Tank Anodes
- Hull Anodes
- Bracelet Anodes

Aluminium Platform / Jetties Anodes

Anode Type	Length (mm)	Width (mm)	Height (mm)	Cores	Net Wt. (Kg)	Gross Wt. (kg)
BTA0866P	740	140	136	1"	35	39
BTA1377P	740	190	162	1"	58	62
BTA1644P	1520	136	126	1"	68	74
BTA2044P	1520	138	152	1.5"	86	92
BTA10088P	2450	306	261	4"	400	454
BTA12622P	2450	340	260	4"	500	568
BTA14333P	3050	282	286	4"	570	645

Weld on - Single Strap

Anode Type(New)	Anode Dimensions(mm)			Core Dimensions(mm)			Weight (kg)	
	Length	Width	Height	Length	Width	Height	Net wt.	Gross Wt.
BTA035W	200	95	33	300	25	5	1.2	1.6
BTA048W	290	90	40	440	30	5	1.7	2.2
BTA055W	300	90	40	400	25	5	2.1	2.5
BTA095W	340	155	35	450	38	5	3.7	4.3
BTA106W	400	150	33	540	40	5	4	4.8
BTA148W	440	105	60	560	30	5	6	6.7
BTA202W	550	130	50	680	50	5	8	9.1
BTA224W	550	130	50	650	40	8	8.4	10.1
BTA246W	550	135	58	680	50	5	10	11.1
BTA302W	550	130	75	680	50	5	12.5	13.6
BTA324W	920	130	50	1075	50	5	13	14.6
BTA437W	920	130	65	1075	50	5	18	19.7
BTA444W	920	160	60	1020	40	8	17.4	20
BTA504W	920	130	75	1075	50	5	21	22.7

SACRIFICIAL ANODE



Magnesium Anode

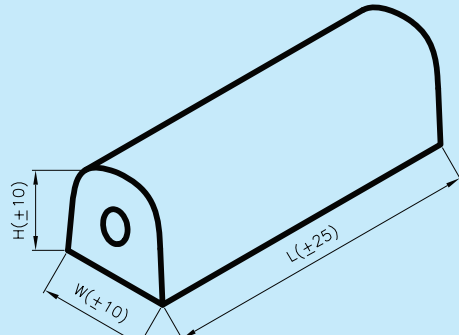

Bare Anode

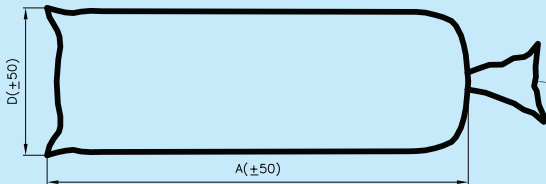

Packaged Anode

SACRIFICIAL MAGNESIUM ANODE

Information

Magnesium Anodes are applied in high resistivity like soil, potable water etc. Standard Magnesium Anodes are available in variety of sizes and weight.

High Potential Magnesium Anodes

FEATURES : Produces high driving voltage compared to other Galvanic Anode.

APPLICATIONS : At high resistivity or high current requirement. Buried Structures in soil of high resistivity such as pipe lines, Storage Tanks etc in soil.

Standard Magnesium Anodes

FEATURES : Produces low driving voltage compared to high potential type.

APPLICATIONS : This type of Anode is useful when the current requirement of the system is less.

Extruded Magnesium Anodes

FEATURES: Influences larger structure surface uniformly produces greater amount of current than Cast Anodes.

APPLICATIONS : Structures buried or submerged in comparatively high resistivity electrolytes.

CHEMICAL COMPOSITION(%)

Product	Mg	Al	Zn	Mn	Si	Cu	Ni	Fe	Other Imp(max)	
					Max	Max	Max	Max	Each	Total
HM	Balance	0.01 max	-	0.5-1.3	0.05	0.002	0.001	0.03	0.05	0.3
SM	Balance	5.3-6.7	2.5 -3.5	0.15-0.7	0.10	0.002	0.002	0.003	-	0.3
EM	Balance	0.01 max	-	0.5-1.3	-	0.002	0.001	0.03	-	0.3

ELECTRO CHEMICAL PROPERTIES

	Open-Circuit Volt (-v respect to Cu/CuSO ₄)	Closed-Circuit Volt (-v respect to Cu/CuSO ₄)	Actual capacity at 50% efficiency (Ahr/Kg)	Current Efficiency(%)
HM	1.7 - 1.77	1.59 - 1.63	1105 min	>50
SM	1.57 - 1.62	1.52 - 1.57	1115 min	>50
EM	1.7 - 1.77	1.59 - 1.63	1105 min	>50

DIMENSIONAL & WEIGHT TABLE

HIGH POTENTIAL MAGNESIUM ANODE

Model No.	Weight (Kg)	Anode Dimensions				
		L mm (±25)	A mm (±50)	D mm (±50)	H mm (±10)	W mm (±10)
BTMG30H	1.4	114	165	152	76	76
BTMG50H	2.3	191	343	152	76	76
BTMG90H	4.1	545	700	150	75	60
BTMG170H	7.7	645	750	200	90	75
BTMG200H	9.1	1524	1588	127	51	51
BTMG320H	14.5	496	700	250	142	130
BTMG400H	18.1	1524	1626	152	76	76
BTMG480H	21.8	700	960	250	150	140
BTMG600H	27.2	1510	1750	250	115	115
BTMG1200H	55	1170	1400	330	170	145(T) 175(B)

EXTRUDED MAGNESIUM ANODE

Section (Inch)	3/8x3/4±0.015
Diameter of core (Inch)	0.135
Core eccentric	<1/16
Weight (lbs / feet)	0.243
Standard coil length (feet)	1000
Coil weight	110

SACRIFICIAL ZINC ANODE

Information

Zinc Anodes are usually applied in Low Resistivity Soils below 1000 -cm and in Seawater or produced Brines. Zinc should not be used when the electrolyte temperature is or exceeds 135°F. Pre packaged Anodes are in standard backfill (75% Gypsum, 20% Bentonite and 5% Sodium Sulphate).

ZINC ALLOYS

Elements	ASTM B 418 Type I MIL A-18001K	ASTM B 418 Type II
Aluminium	0.10 – 0.50	0.005 max
Cadmium	0.025 -0.07	0.003 max
Lead	0.006 max	0.003 max
Iron	0.005 max	0.0014 max
Copper	0.005 max	
Others(each)	0.02 max	
Total others	0.05 max	
Zinc	Remainder	Remainder

Weld on Type Anodes - Single Strap

Anode Type	Anode Dimensions(mm)			Core Dimensions(mm)			Zinc Anode	
	Length	Width	Height	Length	Width	Thk	N.Wt(Kg)	G.Wt(Kg)
BTZ053W	140	70	30	250	25	5	2	2.4
BTZ082W	200	100	25	320	25	5	3.2	3.7
BTZ100W	305	85	45	440	30	5	4	4.5
BTZ111W	305	85	45	440	30	5	4.5	5
BTZ122W	270	100	40	440	30	5	5	5.5
BTZ146W	200	130	35	330	38	5	6	6.6
BTZ191W	300	155	30	405	38	5	8	8.6
BTZ240W	340	150	35	500	38	5	10	10.8
BTZ262W	400	150	33	500	38	5	11	11.8
BTZ284W	400	150	36	500	38	5	12	12.8
BTZ288W	340	150	38	500	38	5	12.3	13
BTZ355W	380	140	38	520	38	8	15	16
BTZ422W	460	140	38	600	38	8	18	19
BTZ466W	535	135	51	680	38	5	20	21
BTZ511W	540	140	40	680	38	8	21.5	23
BTZ555W	680	125	40	740	50	6	24	25
BTZ577W	800	120	40	940	50	5	25	26
BTZ600W	540	140	48	680	50	8	25	27

Zinc Hull Anodes Weld on - Tear Drop

Anode Type	Anode Dimensions(mm)			Core Dimensions(mm)			Zinc Anode	
	Length	Width	Height	Length	Width	Thk	N.Wt(Kg)	G.Wt(Kg)
BTZ012T	120	40	25	200	10	3	0.5	0.55
BTZ024T	180	60	32	260	20	3	1	1.1
BTZ048T	220	75	38	300	20	3	2	2.2
BTZ040T	200	95	30	300	20	3	3	3.2
BTZ235T	275	175	51	405	40	5	10	10.6

Weld on Type Anodes - Double Strap

Anode Type	Anode Dimensions(mm)			Core Dimensions(mm)			Zinc Anode	
	Length	Width	Height	Length	Width	Thk	N.Wt(Kg)	G.Wt(Kg)
BTZ240D	305	152	32	254	32	5	10	10.8
BTZ284D	305	152	38	254	32	5	12	12.8
BTZ333D	305	152	50	254	38	5	14	15
BTZ435D	305	152	64	254	38	5	18.4	19.6

Zinc Hull Anode Bolt On Type

Anode Type	Length(mm)	Width(mm)	Height(mm)	C-C(mm)	Plate Width(mm)	Plate Thickness(mm)	Net Wt.(Kg)	Gross Wt.(Kg)
BTZ084B	200	100	30	110	75	3	3.4	3.8
BTZ055B	200	100	40	110	75	3	4	4.4
BTZ166B	300	150	25	160	75	3	7.1	7.5
BTZ191B	300	150	30	160	75	3	8.2	8.6
BTZ244B	300	150	40	160	75	3	10.8	11
BTZ266B	300	150	50	160	75	3	11.6	12
BTZ337B	300	200	40	160	75	3	14.8	15.2

Electrochemical Properties :

- Solution Potential: -1.05V w.r.t Ag/AgCl
- Capacity: 780 Ah/kg

Customized Alloy, Dimensions and shape can be produced against order

SACRIFICIAL ZINC ANODE



Zinc Anode

- Tear Drop Anodes
- Stand OFF Anodes
- Tank Anodes
- Hull Anodes
- Bracelet Anodes

IMPRESSED CURRENT ANODE



MMO Anode Tubular

MIXED METAL OXIDE ANODE (TUBULAR)

Information

Titanium is chemically resistant & mechanically robust. Mixed Metal Oxide when coated over Titanium activates the latter. The Mixed Metal Coating has an excellent Electrochemical property. The evolution of Oxygen & Chlorine and / or mixtures of the two Gases can be established with a Low Stable Anode Potential.

Composition

Mixed Metal Oxide Coating is a combination of precious groups of Metal Oxides. The Oxide composition has been extensively developed for optimized Electrochemical & Long lifetime in the various Cathodic Protection Environments.

Lifetime

BSS Tech recognizes the simultaneous generation of Chlorine & Oxygen on the stringent environment the Anode inhabit. And so we provide Mixed Metal Oxide to withstand these harsh conditions. Concurrent Anodic generation of Chlorine & Oxygen occurs in Low Salinity / Brackish / Fresh Water. Hydrogen ions co-generated with Oxygen have a particular stagnant Electrolyte flow, which results in very acidic conditions at the Coated Electrolyte Interface. Mixed Metal Oxide Anodes are designed to resist acidic conditions & the coating to the Titanium Interface is protected from Anodic and Chemical attack. It has a very low wear rate in the range of 0.5 to 4 mg/A-year; depending on the specified Cathodic Protection Application & Conditions. The long lifetime behaviour is only because of the Low Electrochemical wear of the Coating provided for a stable low Anodic Operating Potential. We design our Mixed Metal Oxide Tubular Anodes for a lifetime of 10 to 30 years, even longer depending upon the Application & Customer requirement.

Current Outputs

Mixed Metal Oxide Anodes have High Current Outputs. The recommended maximum Current Density depends upon the Resistivity & Composition of the Electrolyte. As with all Anode Systems, the lifetime is a function of the Current Density.

The recommended maximum current outputs are:

Sea water	750 A/m ²	Brackish/ Fresh water	150 A/m ²
Soil (Carbonaceous Backfill)	100 A/m ²	Mud	50 A/m ²

Dimension & Size

BSS Tech Mixed Metal Oxide Tubular Anodes are available in all Lengths & Diameters. We also provide other types of Mixed Metal Oxide Anodes which includes: Rods, Wires, Discs, Sheet, Expanded Mesh, Strip and can be tailor made to suit our Customer's Specification & Requirements. Canistered MMO Anodes also available with different sizes.

Applications

Major applications for Mixed Metal Oxide Anodes include:

- Internal Cathodic Protection for Tanks, Condensers & Heat Exchangers, etc.
- External Cathodic Protection on Pipeline, Ships, Platforms, Jetty Structures, Offshore Structures, Seawater intake structures.
- Buried Structures (used with Carbonaceous Backfill)
- Tank Bottom Protection

MIXED METAL OXIDE RIBBON ANODE

Information

Titanium is chemically resistant & mechanically robust. Mixture of Metal Oxide when coated over Titanium, activates the latter. The Mixed Metal Coating has an excellent Electrocatalytic property. The evolution of Oxygen & Chlorine and / or mixtures of the two Gases can be established with a Low Stable Anode Potential.

Composition

Mixed Metal Oxide Cathodic Protection Coating is a combination of precious groups of Metal Oxides. The Oxide composition has been extensively developed for optimized Electro Chemical & long lifetime in the various Cathodic Protection Environments.

Lifetime

BSS Tech recognizes the simultaneous generation of Chlorine & Oxygen on the stringent environment the Anodes inhabit. And so we manufacture Mixed Metal Oxide to withstand these harsh conditions. Concurrent Anodic generation of Chlorine & Oxygen occurs in Low Salinity / Brackish / Fresh water . Hydrogen ions co-generated with Oxygen have a particular stagnant Electrolytic flow, which results in very acidic conditions at the Coated Electrolyte Interface. Mixed Metal Oxide Anodes are designed to resist acidic conditions & the coating to Titanium interface is protected from Anodic & Chemical attack . It has a very low wear rate in the range of 0.5 to 4mg/A-year; depending on the specified Cathodic Protection Application & Conditions . The long lifetime behaviour is only because of the Low Electrochemical wear of the Coating provided for a stable low Anodic operation potential. We design our Mixed Metal Oxide Ribbon Anodes for a lifetime of 10 to 40 years, or even longer depending upon the Application & Customer requirement.

Current Outputs

Mixed Metal Oxide Anodes can have different output ratings based on the life & current requirements . The recommended maximum Current Density depends upon the Resistivity & Composition of the Electrolyte as with all Anode systems, the lifetime is a function of the Current Density.

The recommended current outputs are:

Size (Width x Thickness)	Current Output				
0.25" x 0.025" (6.35mm x 0.635mm)	17 mA/m	33 mA/m	42 mA/m	70 mA/m	105 mA/m

Applications

Mixed Metal Oxide Ribbon Anode is primarily used for Tank Bottom Cathodic Protection System.

Packing

Mixed Metal Oxide Ribbon Anodes are available in rolls of 250 feet or 500 feet.

IMPRESSED CURRENT ANODE

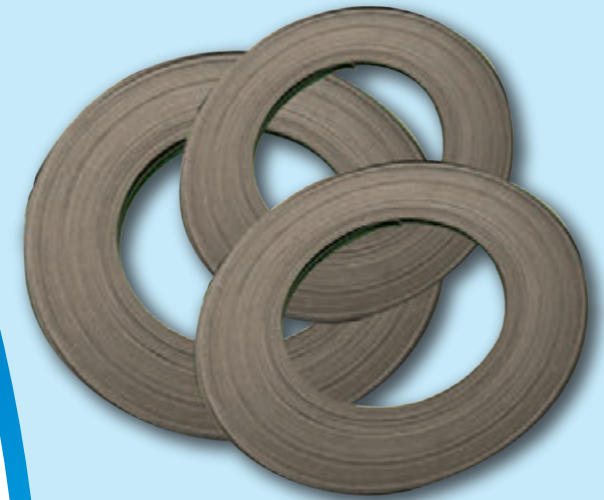

Mixed Metal Oxide Ribbon Anode

PYRAMID ANODE

Information

The Pyramid Anode consists of a four-vaned titanium substrate coated with mixed metal oxide, $\text{IrO}_2/\text{Ta}_2\text{O}_5$, conductive film, mounted on a high-density waterproof concrete pyramid to provide negative buoyancy and sea-bottom stability. Water seals are designed to established engineering principles and do not rely upon the dubious effectiveness of fillers, mastics, resins and the like.

The anode, when fully assembled with special double-armoured insulated cable, requires only the installation contractor to lower the anode on to the seabed and terminate the onshore end of the cable, resulting in minimal installation time, and further cost savings.

The Pyramid Anode is ideally suited for well casing, platforms, sheet piling, jetty piles and all similar offshore facilities with a current output as per customer requirement.

Top piece:

Titanium rod anode with MMO coating with four numbers of TIG welded Titanium Fins with MMO Coating.

One end of the central rod is provided with internal thread suited to assemble on base axle.

Base Piece:

Titanium Base Axle coated with MMO. One end with an external thread to assembly the top piece and other end machined for cable connection with tubular PVC housing.

- **Substrate**

Titanium ASTM B265 Grade1/ 2

- **Coating:**

Oxides of Iridium & Tantalum

Pyramid Anode with Cable

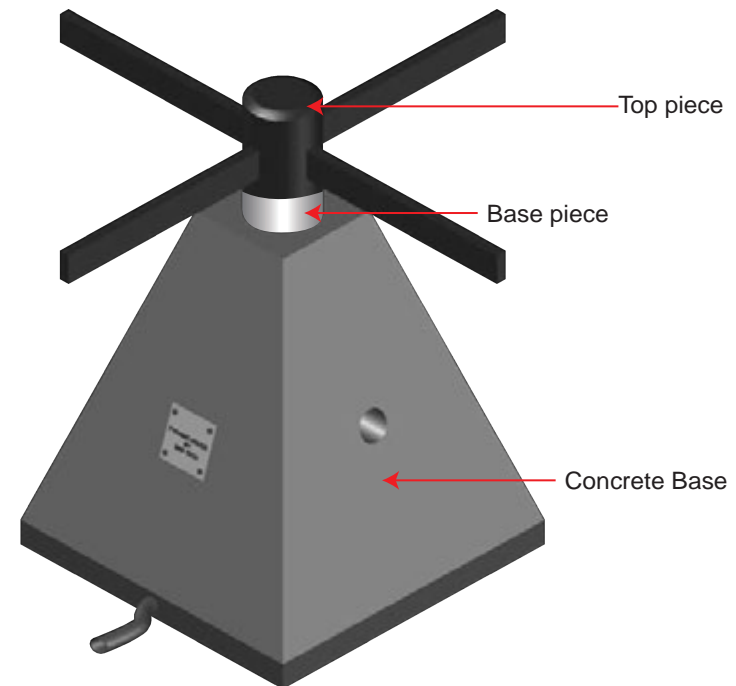

Pyramid Anode

JACKMO™ WIRE ANODE

JACKMO™ Wire Anode is an impressed current, flexible anode used for cathodic protection of buried structures like tank bottom, underground vessel, Piping etc. Anode shall be placed in close proximity to buried metal structure. JACKMO™ Wire Anode provides uniform cathodic protection to every point, with minimum interference from adjacent structures. This anode has the advantage of effective uniform current distribution, long life, flexible in construction, easy installation and lower ground contact resistance. The JACKMO™ Wire anode assembly is mixed metal oxide over titanium substrate (MMO/Ti) piggy backed on 10mm² HMWPE/Kynar cable prepacked with coke breeze in woven fabric tube like sack. Cable size, type and connection frequency can be customized to suit the project requirement.

Specification:

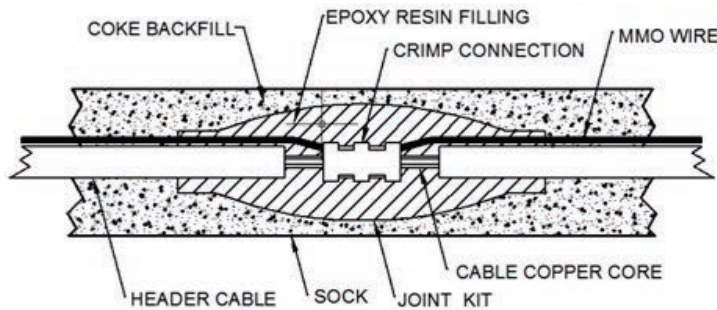

Anode Wire Diameter	1mm	1.5mm	3mm
Maximum Current output *	314 mA/m	471 mA/m	942 mA/m

Design Life	20 years at Max. Current output*
Mixed Metal Oxide Catalyst	Ir-Ta
Titanium substrate	ASTM B348 Grade I / II
Backfill	Calcium Petroleum Coke
Sock Material	Porous non-woven fabrics
Sock dimension	38mm Diameter(Approx)
Length per reel	150 Meters (Customized length at requested)
Cable	To suite design requirements

*NOTE:- Other Rating are also available based on customer request

JACKMO™ WIRE ANODE



IMPRESSED CURRENT ANODE



Graphite Anode

GRAPHITE ANODE

Typical Application

Graphite anodes perform best under Dry Soil conditions, though it operates in Aqueous Environment. The effectiveness of these Anodes are increased with the use of Backfill as it increases the Anode Discharge Surface Area & lowers the Anode -to- Earth Resistance. Graphite Anodes have been successfully used in both Conventional & Deep Ground- Bed applications . They provide excellent Protection in Environments with high Chloride.

Anode Consumption

Graphite is the most commonly used material as an Anode in the impressed Current Cathodic Protection Industry . It is an excellent Conductor of Electricity , Chemically Resistant and is easy to Machine . Due to its proven long term Performance & Economics, Solid Graphite Anode is very popular in ICCP systems.

With strict Quality Control Guidelines , BSS Tech manages a complete line of Graphite Anode . These Anodes are composed of high quality Petroleum Coke mixed with Coal Tar Binders & extruded into Various diameter Rods. Rods are heated repeatedly over 2,600°C and then cooled .The complete process results in Anodes with high percentage of Carbon, which in turn delivers effective Protection at very low consumption rate . The consumption rate varies between 0.4 and 2.0 lbs/A year. (The recommended Current Density for the Graphite Anode is 0.5 A/ft².)

Graphite is Porous

To increase the Anode life the pores are filled with Impregnate. Graphite Anodes are treated with a Microcrystalline Wax. This limits any electrochemical activity to the surface of the Anode and reduces any tendency for the reaction to occur in the Pores . This also acts as a barrier against moisture intrusion which could cause deterioration of the Anode and possibly the Anode Connection. An alternate treatment is a Phenolic Resin, which is recommended for use in severe application Environments.

Fabrication Options

Treatment: Paraffin Wax, Phenolic Resin

Connections: Centre Connected, End Connected, Any Depth

Standard Connection

All Graphite Anodes are precision drilled to Customer's specified depths. The wires are soldered with each Anode assures a quality, fault - free connection . Maximum Electrical Resistance of the connection is 0.0004 & the minimum Pullout Strength is 1000 lbs.

Sizes & Operating Data

Size	Untreated Weight	Treated Weight	Area(ft ²)	Recommended Max A		
				Backfill	Saltwater	Fresh water
3" x 60"	27#	30#	4.0	1.5 - 2.0	2.0	1.0
4" x 80"	65#	72#	7.0	2.0 - 4.0	4.0	2.0

HIGH SILICON IRON ANODE

Anode Consumption

The consumption rate of High Silicon Chrome Cast Iron Anodes have been found to be between 0.2 & 1.2 lbs/A (year). For the Anodes of the same Chemistry & Microstructure, variance in Consumption is primarily due to the Chemical & Physical characteristics of the Anode Environment. The consumption rate does not appear to be significantly affected by Current Density (amperes Per unit area of Anode Surface). The use of Coke Breeze around the Anode in Soil Ground beds will tend to lower the consumption rate. A generally accepted design guideline for Anodes buried in Coke Breeze is 0.7 lbs. per ampere year

Stick Type

TYPE	WEIGHT	ANODE DISCHARGE (A)	DIAMETER	LENGTH	AREA
BTISI-260C	12 Kg. (26 lbs.)	1.5-2.0	1.5" (38mm)	60" (1520mm)	2ft ² (0.19 M ²)
BTISI-460C	20.9 Kg. (46 lbs.)	3.0-4.0	2.3" (58mm)	58" (2134mm)	4ft ² (0.4 M ²)
BTISI-600C	27 Kg. (60 lbs.)	2.0-2.7	2" (50mm)	60" (1520mm)	2.7ft ² (0.25 M ²)
BTISI-1100C	50 Kg. (110 lbs.)	3.0-6.0	3" (76mm)	60" (1520mm)	4ft ² (0.37 M ²)

Tubular Type

TYPE	WEIGHT	ANODE DISCHARGE (A)	DIAMETER	LENGTH	AREA
BTISI-260T	12 Kg. (26.4 lbs.)	1.8-2.2	1.5" (38mm)	60" (1520mm)	2ft ² (0.19 M ²)
BTISI-500T	23Kg. (50 lbs.)	3.2-3.8	2.2" (56mm)	84" (2130mm)	4.2ft ² (0.39 M ²)
BTISI-500T1	23Kg. (50 lbs.)	2.6-3.5	2.6" (66mm)	60" (1520mm)	3.5ft ² (0.39 M ²)
BTISI-700T	32 Kg. (70 lbs.)	3.7-5.0	2.6" (66mm)	84" (2130mm)	4.9ft ² (0.46 M ²)
BTISI-950T	43 Kg. (95 lbs.)	5.3-7.0	3.8" (97mm)	84" (2130mm)	7.0ft ² (0.65 M ²)
BTISI-1100T	50Kg. (110 lbs.)	3.8-5.0	3.0" (76mm)	60" (1520mm)	4.0ft ² (0.36 M ²)
BTISI-1220T	55Kg. (122 lbs.)	6.6-8.8	4.8" (122mm)	84" (2130mm)	8.8ft ² (0.8 M ²)
BTISI-1770T	80 Kg. (177 lbs.)	6.6-10.0	4.8" (122mm)	84" (2130mm)	8.8ft ² (0.82 M ²)

Nominal Discharge : 0.75 - 1.0 A/ft²

IMPRESSED CURRENT ANODE



High Silicon Iron Anode

ZINC RIBBON ANODES

GROUNDING PRODUCTS



Zinc Ribbon

Information

Zinc has proven to be an excellent Anode Material for Cathodic Protection and grounding. To overcome the small impurities which are always present in the base material, conventional Zinc Alloys contain Aluminium. Zinc Anodes have been in use for decades to protect Steel Structures from Corrosion. Today, these anodes are still widely utilized and have proven to be an effective choice for preventing corrosion in selected soils and brackish waters, as a grounding electrode for AC mitigation applications.

Electro Chemical Properties

Open Circuit Potential (-v) 1.05 w.r.t Ag/AgCl, Current Capacity (A - hr/lb) - 372, Galvanic Efficiency (%) = 90 - 95

Features

- High Current Output to volume ratio.
- Easily conforms to any Cathode length or configuration.
- Will not cause nor magnify stray currents.
- Generally used in soils of 1000 ohm cm or less with prepared Gypsum-Clay Backfill.
- The Ribbon for AC mitigation is laid parallel to the cross country pipeline, laid as mats and in spiral for localised grounding

Applications

- External areas of Steel Pipe
- Tank bottom Cathodic protection of above grade storage tank.
- In the limited space between Casing and Carrier Pipes.
- In the limited space between inner and outer Casings of Wells of various kinds.
- Grounding of cross country pipelines
- Interstitial spaces between old, corroded and new Storage Tank Bottoms.



*Zinc Ribbon for Road Crossing,
AC mitigation, etc...*

Product Size	Plus	Standard	Small
Cross Section Inches (mm)	5/8" x 7/8" (15.88 x 22.22)	1/2" x 9/16" (12.7 x 14.28)	11/32" x 13/32" (8.73 x 10.32)
Pounds / Foot (Kg / m)	1.2 (1.79)	0.6 (0.89)	0.25 (0.372)
Dia. of wire core Inch (mm)	0.135 (3.43)	0.130 (3.30)	0.115 (2.92)
Standard coil length Feet (mm)	200 ⁺²⁰ _{+6.1} (61-0)	500 ⁺³⁰ ₊₉ (152-0)	1000 - 0 ⁺⁵⁰ ₊₁₅ (305-0)
Standard coil ID Inch (cm)	36 (91.44)	12 (30.5)	12 (30.5)
Packaging	Steel banded open coil	Wooden Reels	

PLATINIZED TITANIUM ANODES

The substrate, usually titanium, is chemically resistant and mechanically robust. The substrate is activated by platinum coating. The coating has excellent electrocatalytic properties. The evolution of oxygen and chlorine and/or mixtures of the two gases is therefore achieved at low stable anode potential.

Composition

Anode comprises of a thin layer of platinum coated on titanium substrate.

Type of Anodes

Anodes are available in all shapes and forms including the following:

Rods, Wires, Tubes, Discs, Sheet, expanded mesh, strip and are custom made to the customer application and requirements.

Copper Cored Anodes are also available.

Applications:

- Internal Cathodic protection of tanks, condensers, pipelines & heat exchangers.
- External Cathodic protection of shiphulls, platforms, piers, dams, offshore structures & powerstation-inlets
- Buried structures (used with carbonaceous backfill)
- Tank bottom protection

Platinized Niobium Anodes – ICCP System

In modern ICCP-systems, Titanium and Niobium anodes are used. To realise a continuous current electrical conductivity and a long lifetime, the anodes are applied with a thin layer of Platinum.

The composition and thickness of these coatings determine the working and the lifetime of the ICCP-systems. The construction, the electrical output, current density and the characteristics of the electrolyte (freshwater, seawater, etc.) determine the size and shape of the anodes

Frequently employed applications

- Internal Cathodic protection of storage tanks, condensers, pipes, pipelines, heat exchangers and boilers.
- External Cathodic protection of pipelines, ship hulls, platforms and other offshore constructions, piers, dams and cooling water inlet parts of power stations.
- Tank bottoms.

We can provide this product to your specification and requirements

IMPRESSED CURRENT ANODE



Platinized Titanium Anodes



Niobium Anodes

REFERENCE ELECTRODES



Portable Reference Electrodes



*Permanent Pre Packaged
Underground Reference Electrodes*



Zinc Reference Electrode

PORTABLE REFERENCE ELECTRODES

Copper / Copper Sulphate

Liquid or Gelatine Filled space age Porous Ceramic Plugs High Impact ABS Plastic (yellow) Housing Corrosive Environment Resistant Chloride Ion Trap Equipped Copper Sulphate.

- Connection Stud : 1/4" - 20 Copper
- Size : 1" dia. x 8" Housing
- Stability : ± 10 mV with 3.0 microamp load
- Temperature Range : 0° C to 57.2° C (32° F to 135° F)

Silver / Silver Chloride

Liquid or Gelatine Filled Space Age Porous Ceramic Plugs High Impact ABS Plastic(Blue) Housing Corrosive Environment Resistant Chloride Ion Trap Equipped Silver Chloride.

- Connection Stud : 1/4" - 20 Brass
- Size : 1" dia. x 8" Housing
- Stability : ± 10 mV with 3.0 microamp load
- Temperature Range : 0° C to 65.5° C(32° F to 150° F)

Zinc/ Zinc Sulphate

Liquid or Gelatine Filled Space Age Porous Ceramic Plugs High Impact ABS Plastic (Red) Housing Corrosive Environment Resistant Chloride Ion Trap Equipped Zinc Sulphate.

- Connection Stud : 1/4" - 20 Plated Brass
- Size : 1" dia. x 8" Housing
- Stability : ± 10 mV with 3.0 microamp load
- Temperature Range : 0° C to 57.2° C (32° F to 135° F)

Portable Reference Electrodes are available with extension Rod water immersible Cable Connections and end weights for Specific Application.

PERMANENT REFERENCE ELECTRODES (FOR SEA WATER APPLICATION)

Zinc Reference Electrode

- Size : 2" dia. x 10" Long
- Lead Wire : Custom Made
- Weight : Approx. 30 lbs Dimensions & Sizes can be Tailor Made
- Design life : 30 years

PERMANENT PRE PACKAGED UNDERGROUND REFERENCE ELECTRODES

Copper / Copper Sulphate

(for soil 200 ppm Chloride or less) High Impact ABS Plastic Tube Packaged (Yellow Cotton Bag) in Special Non-Polarizing Backfill

- Size : 2" dia. x 7" Pack
- Weight : Approx.15 lbs Dimensions & Sizes can be Tailor Made
- Lead Wire : Standard 50' of # 14 RHH - RHW / Custom Made
- Stability : ±5 mV with 3.0 microamp load
- Overall Size : Approx. 6" dia. x 14"
- Reinforced Rods : 1/4" x 3" PVC @ Electrode End
- Design Life : 30 years
- Temperature Range : 0° C to 57° C (32° F to 132° F)

Silver / Silver Chloride

(for soil 200 ppm chloride or higher) High Impact ABS Plastic Tube Packaged (Blue Cotton Bag) in Special Non-Polarizing Backfill

- Size : 2" dia. x 7" Pack
- Weight : Approx. 15 lbs Dimensions & Sizes can be Tailor Made
- Lead Wire : Standard 50' of # 14 RHH - RHW / Custom Made
- Stability : ±5 mV with 3.0 microamp load
- Overall Size : Approx. 6" dia. x 14"
- Reinforced Rods : 1/4" x 3" PVC @ Electrode End
- Design Life : 30 years
- Temperature Range : 0° C to 65.5° C (32° F to 150° F)

Zinc / Zinc Sulphate

(for soil 200 ppm chloride or less) High Impact ABS Plastic Tube Packaged (Red Cotton Bag) in Special Non-Polarizing Backfill

- Size : 2" dia. x 7" Pack
- Weight : Approx. 15 lbs Dimensions & Sizes can be Tailor Made
- Lead Wire : Standard 50' of # 14 RHH-RHW / Custom Made
- Stability : ±5 mV with 3.0 microamp load
- Overall Size : Approx. 6" dia.x 14"
- Reinforced Rods : 1/4" x 3" PVC @ Electrode End
- Design life : 30 years
- Temperature Range : 0° C to 57° C (32° F to 132° F)

MMO MESH RIBBON ANODE - Concrete Cathodic Protection

Anode Ribbon Mesh is a key component for Cathodic Protection systems in new reinforced concrete structures. It is composed of a precious metal oxide catalyst sintered onto an expanded titanium mesh substrate.

MATERIAL SPECIFICATIONS

Anode Performance:

Maximum anode concrete interface current density:

FHWA limit: 110 mA/m²

Short-term limit: 220 mA/m²

Type	Width	Current Output	Anode Surface Area
A	10 mm	2.8 mA/m	0.027 m ² /m
B	13 mm	3.5 mA/m	0.032 m ² /m
C	19 mm	5.28 mA/m	0.048 m ² /m

Expected life (NACE Standard TM 0294-2016): 75 years

Catalyst: Mixed Metal Oxide

Expanded thickness: 0.9-1.3 mm

Dimensions common to all types

Substrate:	
Material	Titanium, Grade 1, as per ASTM B265
Coefficient of thermal expansion	8.7 x 10 ⁻⁵ /° K
Thermal conductivity at 200° C	15.6 W/m° K
Electrical resistivity	0.000056 ohm-cm
Modulus of elasticity	105 GPa
Tensile strength	245 MPa
Yield strength	175 MPa
Elongation	24% minimum

Titanium Conductor Bar	
Type	Solid Ribbon
Material	Titanium, Grade 1, as per ASTM B265
Dimension	12.7mm (W) x 0.9mm (T)
Electrical Resistance	0.11 Ohm/m

MMO TITANIUM MESH RIBBON ANODES



TITANIUM CONDUCTOR BAR

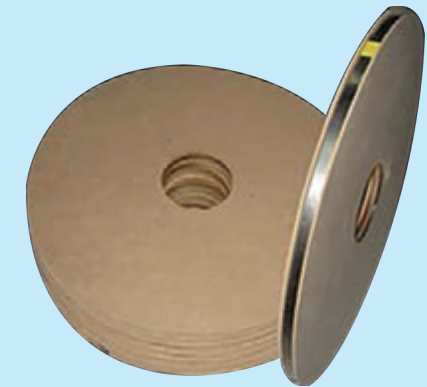

CORROSION RATE MONITORING PROBES



Ag/AgCl Reference Electrode



CORROSION RATE MONITORING PROBES - Concrete Cathodic Protection

Corrosion rate monitoring probes are designed for installation during the construction of structures to provide information on the corrosion of the reinforcement and the condition of the concrete. This is done in the form of the following measurements:

- Corrosion potential (E_{corr}) of the probe working electrode and the main reinforcement with respect to the probe reference element.
- Corrosion rate (I_{corr}) of the probe working electrode and the main reinforcement using the linear polarization resistance (LPR) method
- Concrete Resistivity
- Concrete temperature



Major Applications – Concrete Cathodic Protection

We can provide this product to suit your specification and requirements

Silver / Silver Chloride Permanent Embeddable Reference Electrode

Information

Silver / Silver Chloride reference electrode is specially designed for concrete application having stable potential and long life. The components are Silver metal, Silver chloride, silver ions and chloride ions.

Stability - Less than $\pm 3\text{mV}$ in 24 hours. Less than $\pm 10\text{mV}$ expected in 20 years.

Life in Concrete - more than 30 years at a leakage current of 1mA

Housing - ACETAL Plastic / Nylon tube.

Contact surface - Micro porous plug

Temperature range: -5°C to 70°C

Approx. overall dimension - 4" long x 1" dia.

Potential:

$-15\text{mV} \pm 10\text{mV}$ versus the Saturated Calomel Electrode (SCE)

$230\text{mV} \pm 10\text{mV}$ versus the Standard Hydrogen Electrode (SHE)

Cable:

Supplied to order as required

QA/QC:

All reference electrode are factory calibrated and supplied with calibration certificates.

GROUNDING PRODUCTS

Applications

Zinc Grounding Cells are used for AC Mitigation. This is used to bleed off AC from the structures, which are subject to induced AC. Zinc Grounding cell can be installed at high voltage O/H crossing or parallelism locations.

Information

Zinc Grounding Cells consist of one, two or four Standard Zinc electrodes separated with 1" Insulating Spacers (for more than 1 electrode). Nominal resistance of a two electrode Grounding Cell in wet area is 0.2 to 0.6 Ohm. Nominal Resistance of a four electrode cell is one fourth to one half that of a two electrode cell. The Grounding Cells are packed in standard backfill (75% Gypsum, 20% Bentonite and 5% Sodium Sulphate) either in a unit of one, two or four.

Composition (ASTM B 418 TYPE 1)

ELEMENT	CONTENT(%)
Cu	0.005 max
Al	0.10 - 0.50
Fe	0.005 max
Cd	0.025 to 0.07
Pb	0.006 max
Zn	Remainder
Potential	-1.05 Volts w.r.t Ag / AgCl
Capacity	780 amps Hr./Kg.

Zinc grounding cells help to bleed off unwanted voltages. They reduce the danger of shock on a steel structure, arcing and burning of insulated joints. Zinc grounding cells form an unavoidable part of any induced AC power mitigation, protection of IJ's and IF's, earthing of a structure, etc.

Polarization Cell Replacement (PCR)

PCR is a solid-state device designed to simultaneously provide DC decoupling and AC continuity/grounding when used with cathodically protected structures, such as pipelines, tanks, grounding systems, and cable casings. The PCR has very high AC fault current and lightning surge current ratings. Polarization cell replacement (PCR) are used in conjunction with grounding cells.

Isolation Flange Kits and Surge Arrestor

Isolation Flange Kits are used in flanges to isolate the protected and un-protected sides of the pipeline. It consists of a non-metallic gasket, washer, sleeve and metallic washer. Surge Arrestors are used to bypass the surges between isolated structures and protect the insulating materials.

Standard Zinc Grounding Cells

MODEL	NET WEIGHT	GROUNDING CELL DIMENSION (L x W x D) (MM)	GROSS WEIGHT
BTZN - 180 G	8.1 Kg.	37 x 37 x 915	32.0 Kg.
BTZN - 330G	14.9 Kg.	37 x 37 x 1524	44.7 Kg.
BTZN - 570G	25.7 Kg.	760 x 65 x 75	55.2 Kg.
BTZN - 600G	27.2 Kg.	51 x 51 x 1524	58.9 Kg.

Surge Arrestor



GROUNDING PRODUCTS



Zinc Grounding Cell



Polarization Cell Replacement (PCR)

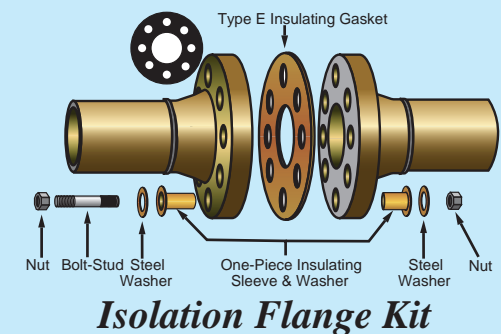

Isolation Flange Kit

GPS TIMER



GPS CURRENT INTERRUPTERS

Current interrupters are used in CP survey. TR unit output is switched ON and OFF at same instant. Usually TR units are placed far way from each other and it becomes difficult to achieve time synchronization. GPS interrupter provides solution for time synchronization.

BSS TECH GPS interrupter has all necessary features required CP survey.

The GPS interrupter is made rugged. The equipment has bright LCD displays which helps operator to use the display under the bright sun. The multiple keys membrane key pad makes it convenient for the operator. In built programme storage capability and the real time clock back up battery gives the freedom to leave the unit un attended for several days. Auto synchronisation does the checking of the clock with the Satellites and continues with the accurate timer, which gives accurate interruption when multiple units are installed for surveys. Activating night sleep will enhance the battery service.

GPS

The global positioning system is a satellite-based navigation system consisting of a network of 24 orbiting satellites that are eleven thousand nautical miles in space and in six different orbital paths. The satellites are constantly moving, making two complete orbits around the Earth in just under 24 hours. One can receive satellite signals anywhere in the world, at any time. The biggest benefits over previous land-based navigation systems is GPS works in all weather conditions.

This Satellite Clock information is as accurate as Atomic Clock and this is used as Time Source for our Timers achieving the most accurate synchronisation possible. The conventional Electronic clock has limited time accuracy. Most commonly used Industrial Real time clock claim accuracy of ± 15 seconds per month i. e. $\frac{1}{2}$ second per day. Further the clock accuracy depends on various factors like external temperature, aging of components etc.

The system consists of

1. GPS Antenna.
2. Coaxial cable with MCX connectors.
3. GPS Interface Module.
4. Timer with User Interface.

Brief Specification

1. Microcontroller based digital circuitry.
2. ON time and OFF time independently adjustable from 0.1 to 999 Sec.
3. Built-in GPS Module with Lat-Log display feature
4. Built-in Real Time clock with Quartz crystal time base for high timing accuracy.
 - Typical accuracy +2 PPM (170mS per 24 Hrs.) in non GPS Mode.
 - Typical accuracy +5 PPB (1mS per 24 Hrs.) in GPS Mode.
5. Dust proof membrane key board for programming.
6. Digital LCD display for showing real time, ON/OFF cycle time, & Lat-Log parameters
7. Lithium Battery back-up for real time clock.
8. Programmable operation for Automatic Start & stop of Timing Cycle.
9. Provision for synchronisation with other timers or with external master clock .
10. Night sleep feature
11. Power fail compensation and auto re-start during Synchronised operation
12. Power Supply : 12V DC or 230V AC
13. Capacity to Interrupt up to 100A DC or AC current
14. Battery back up

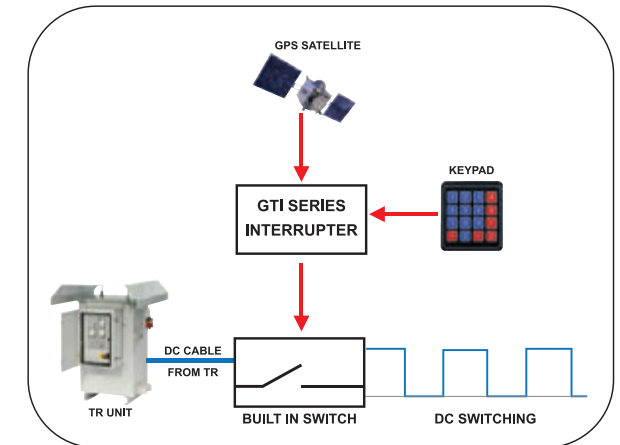

MPPT CHARGE CONTROLLER

MPPT charge controllers, CC series is for off-grid solar system and control the charging and discharging of the battery, especially suitable for Cathodic Protection Application. The controller features a smart tracking algorithm inside that maximizes the energy from the solar PV module(s) and charge the battery. CC series is very simple to configure and use. This series of charge controllers are optimized for long battery life and improved system performance.

Features:

- Intelligent Absorption charge time adjustment.
- Optimized battery charge protection
- Enhanced Sleeping Mode
- Enhanced Power Saver Modes
- Over charging and Short circuit protection
- Efficient Thermal Design and Cooling

Basic Architecture of CC Powered CP

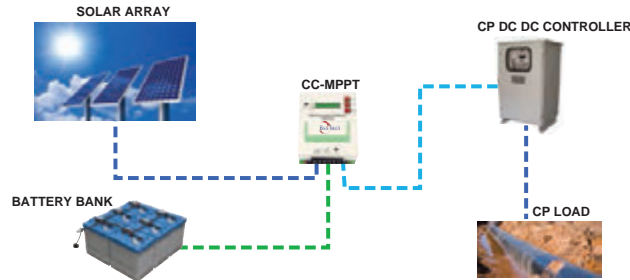

Technical Feature:

	CC-MPPT-1224-20/40	CC-MPPT-36-20/40	CC-MPPT-48-20/40
Technology:	Dual Channel Interleaved Buck Converter		
Battery bank voltage:	12 / 24V	36 V	48 V
Maximum Charging Current:	20 A / 40 A	20 A / 40 A	20 A / 40 A
Maximum Solar Panel Voltage:	70 Volts	100 V	100 V
Maximum Power Point Voltage Range:	Battery voltage to 70V	Battery voltage to 77 V	Battery voltage to 77 V
Buck Converter Duty Cycle Range:	0 – 100%	0 - 100%	0 - 100%
Idle Current from Battery (Typical):	21 / 18 mA (Sleep Mode)	21 / 18 mA (Sleep Mode)	21 / 18 mA (Sleep Mode)

Product Range:

MODELS	Nominal Battery Voltage	Maximum Charging Current	Maximum Solar Panel Voc
CC-MPPT-1224-20	12 / 24 V	20 A	70 V
CC-MPPT-36-20	36 V	20 A	100 V
CC-MPPT-48-20	48 V	20 A	100 V
CC-MPPT-1224-40	12 / 24 V	40 A	70 V
CC-MPPT-36-40	36 V	40 A	100 V
CC-MPPT-48-40	48 V	40 A	100 V
CC-MPPT-1224-20H	12 / 24 V	20 A	150 V
CC-MPPT-36-20H	36 V	20 A	150 V
CC-MPPT-48-20H	48 V	20 A	150 V
CC-MPPT-1224-40H	12 / 24 V	40 A	150 V
CC-MPPT-36-40H	36 V	40 A	150 V
CC-MPPT-48-40H	48 V	40 A	150 V

MPPT CHARGE CONTROLLER

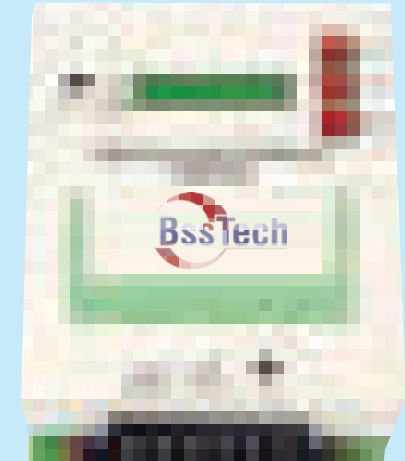

ANTI FOULING SYSTEM



Conventional grid Anti Fouling System

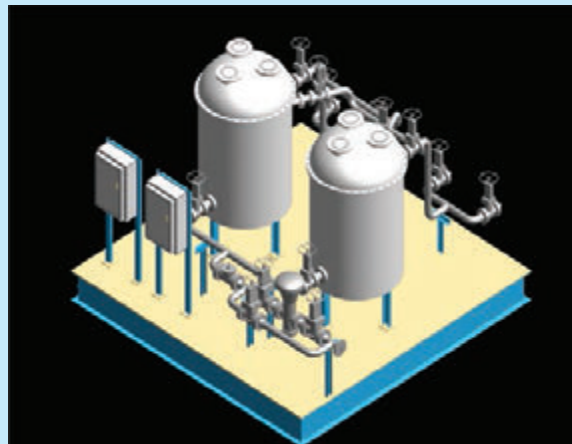

Skid Mounted Anti-Fouling System

ANTI FOULING SYSTEM

Description

The cathode is formed with an insulated steel frame containing copper and aluminium anodes making use of impressed current system basics. The anode/cathode unit is suspended / placed at the pump inlet so that all the water entering the pump must pass the electrode unit. Dosage levels of copper ions are extremely small and measured in micrograms per litre of seawater. Therefore, relatively small quantities of copper are required to provide protection dependent upon the flow rate and life required.

Anti fouling system consists of two parts “the electrode unit and the control panel. The electrode assembly contains mainly copper anodes. Aluminium Anodes are used in combination with copper in some applications. The actual number and size of the anodes is calculated to suit each installation and available space for mounting the electrode unit. The anodes are connected to the constant current rectifier located within a safe area. For variable pump flow, an intelligent logic is utilized in power supply to provide right dosage of ions.

Basically there are three types of systems.

- 1. Conventional grid Anti Fouling System** - The conventional Grid Anti-Fouling system has the capability to deliver ions in the open sea at the mouth of the pipe or channel which is at risk of fouling.
- 2. Strainer System** – Strainer Anti-Fouling systems are fairly small units shaped like Strainers and are attached at the mouth of the pipe or at the mouth of the pump inlet. These are mostly vertically installed.
- 3. Skid Mounted Anti-Fouling System** – Skid Mounted produces the copper ions in a process vessel. The produced treated water is then delivered to the right part of the inlet in the right proportion to set the required ppb level.

All these systems can be prepared with logics to control automatically the production of ions and dispatch of ions depending on the variation in flow rate. The system is intelligent enough to decide the production from minimum to the maximum designed while the flow is zero to the maximum for the pump.

Benefits of our Anti-Fouling System Include:-

- Reduction in power requirements
- Low maintenance system
- No handling or storage of chemicals required
- Environmentally acceptable



Aluminum anode & Copper anode

MARINE CATHODIC PROTECTION

BSS Tech has introduced marine cathodic protection services to serve the corrosion control needs of the marine industrial structures like **jetties, offshore platforms, offshore pipelines, ships, Jack up rigs, Harbor Quays, Submarines, Offshore wind foundations** etc.

Deep water platforms and pipelines present new challenges for design, maintenance, inspection and retrofit of corrosion control systems. Our expertise includes marine survey, CP systems, Anti-Fouling systems & retrofits

Marine Surveys

The advent of the remotely operated vehicle & other survey techniques has radically altered corrosion survey and inspection practices. BSS Tech can render the below mentioned surveys with our expert engineers to gather, analyze and interpret data as per international standards. Several factors like water depth, water currents, location, depth of burial, size or length, cathodic protection system age and cost etc, determines which type of method to be used.

We offer the following services for offshore pipeline & structures:

- ROV Surveys
- Towed Fish / Trailing Wire Surveys
- Drop Line Platform Survey
- Guy Line Platform Survey
- Remote Electrode Submersible Survey
- Trailing Wire Landfall / Outfall Surveys
- Hybrid / Trailing Wire Surveys

Marine/Offshore structures can be protected by different means of CP systems

- **Sacrificial Anode System**

The structures which are commonly protected using SACP systems includes ship's hulls, propellers, Ballast tanks, Sea water intakes.

- **Impressed Current Anode System**

A well known reliable system used to protect marine offshore structures is by ICCP system. The correct placement of ICCP components is the critical factor for balanced operation and is necessary to provide uniform current distribution and sufficient current density.

- **Anti Fouling System**

An effective anti fouling system enhances the efficiency of the marine vessels and offshore structures by preventing bio fouling.

Different types of Anti Fouling system includes

1. Conventional grid Anti Fouling System
2. Strainer System
3. Skid Mounted Anti-Fouling System



MMO Elliptical Anode for Vessel

MMO Linear Anode for Vessel

MARINE CATHODIC PROTECTION

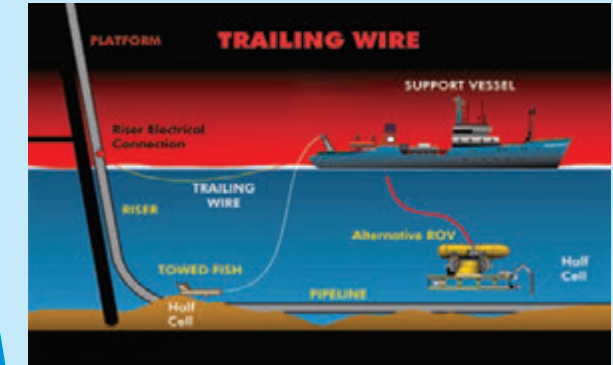

AC MITIGATION MODELLING



Introduction

Pipelines running into close proximity with electric power transmission and distribution systems will occur electromagnetic field created by the alternating current (AC) (expands and collapses and changes direction 120 times per second). An alternating electromagnetic field will exhibit an induced voltage on the pipeline. In addition, power conductor faults to ground can cause substantial fault currents in the underground structure. Stray alternating currents can cause corrosion on pipelines, damage to the coating, resulted in metal loss and pipeline leak. Even though the corrosion weight loss for AC currents is less than for equivalent DC currents, the magnitude of AC stray current is often large—hundreds of amperes under electromagnetic induction and thousands of amperes during power line faults. These high current levels can produce a shock hazard for personnel and can damage the structure and related equipment. There are three basic methods by which AC currents and voltages appear on metallic structures near AC power lines such are Electrostatic coupling, Electromagnetic induction and Resistive coupling.

Need of Mitigation

AC interference on the pipeline due to inductive, capacitive and resistive coupling between the power line and the pipeline produces the following risks:

- Shock to personnel under normal (steady state) operation
- Shock to personnel under fault conditions
- Electrical arcing under fault conditions causing puncture or damage to pipeline
- AC-enhanced corrosion under steady state operation
- Damage to the coating due to electrical stress under fault condition

Mitigation Modelling

Mitigation Modeling is used to compute/model the AC interference pattern in cases where either one component (OHL or Pipeline) is absent or energized.

Physical Testing

- AC Testing
- Measurement of AC voltage to Ground
- Pre Testing (In case of Existing OHL & Pipeline)
- Safety

MONITORING ANODE

Monitoring anode performance can help operators predict overall CP system life.

Anode monitoring system provides a reliable, accurate method for monitoring anode performance and consumption. This is designed to monitor and confirm performance of the Sacrificial Anodes. Monitoring Anode System have an excellent record of success and are found on more offshore structures worldwide than any other fixed-monitoring system. They have been applied to all galvanic anode types, including platform anodes, flush-mount anodes, onshore and offshore pipeline bracelets.

A standard monitoring anode consists of the sampled anode installed with isolation on structure and wired to the monitoring panel. Anode isolation from the structure is achieved by having an isolation joint.

A most sophisticated monitoring anode consists of total remote monitoring with switching capabilities.

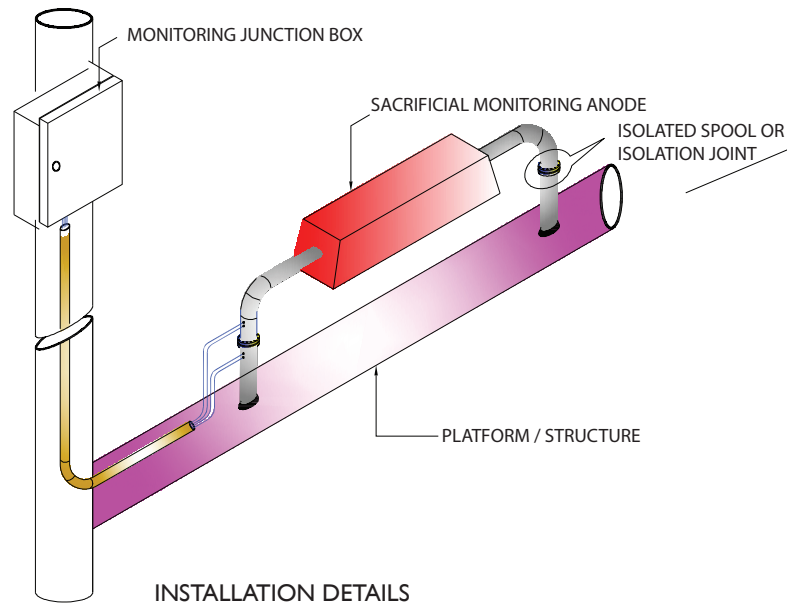

Monitoring system shall be designed to meet the following requirements :

- Anode monitoring system allows operators to accurately measure anode consumption and remaining life without interference with the anode. The data for a handful of anodes will give general trends for the entire cathodic-protection system.
- The performance of the Sacrificial Anodes are judged by the measurement of current output of Individual Anodes.
- Structure potential can be measured using Zn or Ag/AgCl Reference Cell for the potential at the rated current out from anodes
- Verification of anode performance allows corrosion engineers to evaluate not only the design of a particular system, but the design methodology in general.

MONITORING ANODE

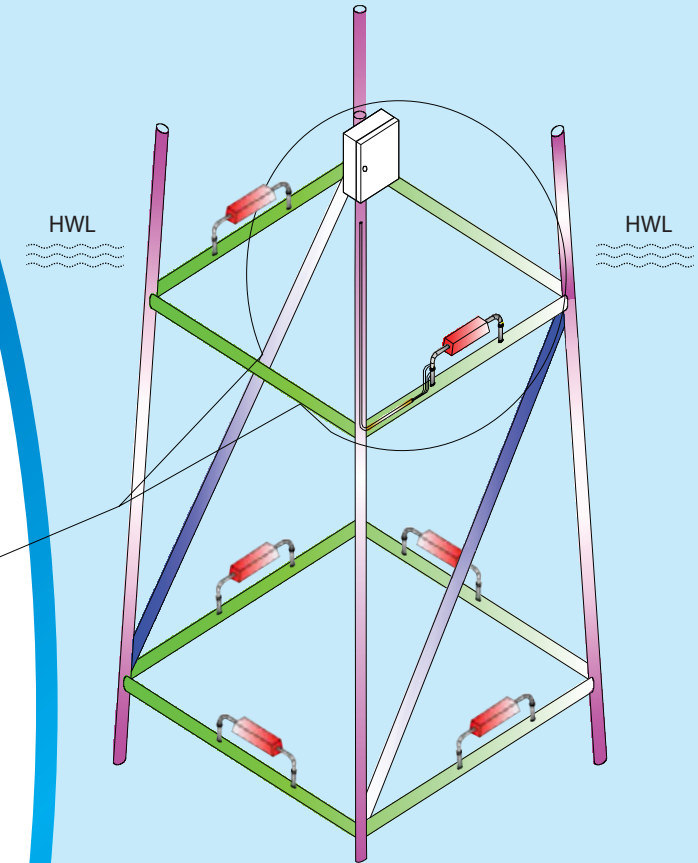

MONITORING ANODE INSTALLATION LAYOUT

HYPOCHLORITE RECTIFIER



HYPOCHLORITE RECTIFIER

We manufacture High power rectifiers that serve hundreds of industrial, commercial and research applications. These industrial applications require the use of direct current ranging from 1KA to 10KA for power ratings of 100kW to 1MW. We offer both standard and highly customized designs for your rugged industrial application.

Rectifier cooling options for these supplies include forced-air, oil cooled, direct water, convection as well as a variety of closed loop systems. Our highly customizable systems also feature a variety of control and monitoring options, which include digital and analogue communication for interface with an upstream PLC or computer system.

Applications

Custom designed units for applications that include:

Steel Plants <ul style="list-style-type: none"> • Continuous Strip • Cranes • Electromagnets • DC Shop Power 	Electrochemical Processes <ul style="list-style-type: none"> • Chlorine • Hydrogen • Oxygen 	Electro winning Processes <ul style="list-style-type: none"> • Copper, Cobalt, Gold, Zinc, Lithium, Silver etc.
	Electrochlorination Systems <ul style="list-style-type: none"> • Desalination • Hypo-chlorination 	Mining Applications <ul style="list-style-type: none"> • Underground Locomotive traction supplies • DC Shop Power
	Resistive Heating	

High grade, hermetically-sealed semiconductors are mounted on heat sinks and are protected with quick-acting silver sand fuses. The PIV rating of all semiconductors used is well above the ratings specified in standards. This increased PIV margin yields additional transient voltage protection and a higher mean time between failure (MTBF).

Rectifier Transformer

Transformer coils are wound with continuous copper conductors, varnish impregnated, and then oven baked for protection against dust, moisture, and fumes.

On a core using interleaved sheets of high-grade, grain-oriented silicon electrical steel designed for high efficiency.

Thermal-overload sensing devices are included in each leg of the transformer to detect winding over temperature due to single phasing, overloading or loss of cooling.

Enclosure

Enclosures are rigid, welded, free-standing, self-supporting painted cold rolled sheet steel. The base of the rectifier assembly is a heavy duty assembly formed from structural steel members with provisions for fork lifting of the supply.

The front and rear of the enclosure is serviceable through lockable, latch-type full length doors or panels. We can manufacture custom designed units with any rating, cabin and Colour. Enclosures are treated with two coats of a suitable primer and two coats of light gray RAL7035. Custom paint colors available upon request.

Remote mentoring and control can be provided through Analogue Transducers and Potential free contacts. These can be hooked to Customer PLC/DCS system.

Standalone Digital Remote Monitoring and control can also be provided through RS485 serial link.

COMPOSITE REPAIR SOLUTIONS

As part of BSS Technologies enhancing its products and services to the existing clientele, we offer proven, reliable and cost-effective composite repair solutions.

These products were developed in response to the industry's need for cost-effective, reliable and environmentally friendly solutions.

Composite Repair Wrap – is developed for quick, fast curing, in-situ and cost effective repairs for high temperature application upto 250° C. The product application is flexible for tight access and complex shaped piping, pipelines and equipment. The repair system can restore the functionality of corroded and leaking pipelines whilst providing protection against further corrosion attack and can be applied at high temperature operating pipelines.

Clamp Type Protection – effectively integrating three attributes of online leak sealing technology: clamp, sealant and injection tools. It is designed to contain the leak point by introducing higher pressure than leaking system pressure by hydraulic injection tools to fill the clamp cavity with sealant compound. The sealant compound are capable of covering leaks within wide range of temperatures and pressures, also compatible with most type of chemicals.

Anti Corrosion Cap – is proven to be cost effective in protecting nuts & bolts from corrosion.

Flange Protection - system prevents crevice corrosion problems at flanges. When applied together with Anti - Corrosion Cap for the nuts and bolts, it provides total corrosion protection for flanges. It involves injecting gel to temporarily fill the void. The material is heated to lower its viscosity allowing it to penetrate all the crevices. Flange Protection contains UV tracers which under UV light cause a light blue fluorescence for checking treatment.

Tubular Pile Protection – utilizes the natural power of currents, wave and tide to break down the marine colonization process on jetty piles, platform jacket legs and well conductors thus prevents marine growth.

Composite Repair Solutions



Composite Repair Wrap

Clamp Type Protection



Straight Pipe Clamp



Flange Clamp



Elbow Clamp

Tubular Pile Protection

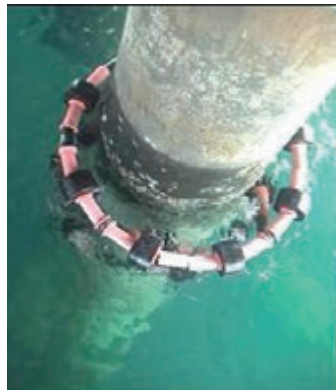

Flange Protection



Anti-Corrosion Cap

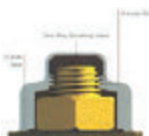

LORESCO®



SC-3® Earth Contact Backfill

LORESCO® manufacturers impressed current anode backfill for all field conditions. LORESCO® SC-3® is designed specifically for demanding anode systems. LORESCO® meets all standards for impressed current anode backfill. SC-3® carries an NSF certification. Other LORESCO® products are Replaceable Deep Anode Systems, AllVent™ and PermaPlug™. These products represent the finest innovations available for the deep-anode cathodic protection industry. For quality, service, and price, specify LORESCO®

INSTALLATION

LORESCO® SC-3®, due to its dust-free manufacture, is simple to install by either mixing and pumping or by pouring dry. With deep anode systems, pumping from the bottom up is recommended. LORESCO® SC-3® has superb pumping qualities due to the addition of surfactants and when agitated in water, takes on the characteristics of heavy mud. A recommended mix is seven gallons of water per one-hundred pounds. After installing SC-3®, allow twenty-four hours settling time before energizing. The modified surface of the carbon particles coupled with the action of the surfactants in SC-3® will achieve positive electrical contact by settling. Vibrating or compacting is not necessary. See installation section in this catalog for additional pumping data.

MATERIAL DESCRIPTION

LORESCO® SC-3® is a surface modified, blended, and sized carbon backfill with surfactants.

- Predominantly round particles
- All particles surface modified for maximum electrical conductivity and high current applications
- Particle sizing to be dust free with a maximum particle size of 1 mm
- Minimum calcination temperature of base materials is 1250 C
- Base materials are calcined under ISO 9002:2000 quality control
- Surfactants are added to assist pumping and settling
- No de-dusting oils are used during the manufacture of base particles

SPECIFICATIONS

Fixed Carbon:	99.35%
Ash:	0.6%
Moisture:	0.05%
Volatiles:	nil (950 C)*
Bulk Density:	74 lbs. per cubic foot

The photo below is a magnification of Loresco SC-3

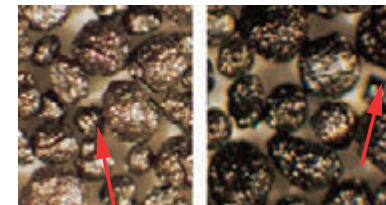

Particles Before Coating Particles after Coating



Certified to
NSF/ANSI 60

DEKOTEC GMBH

Buried steel pipes for the transport of liquid and gaseous media are protected against corrosion by coating with thermoplastic material or thermosetting compounds. While coating of the pipe is done in the factory, some parts and installations of a pipeline remain that have to be coated on the construction site. Depending on pipe laying method, trenchless or in open trench, only welded joints or also bends, T-pieces, flanges and valves have to be protected in the field.

Based on materials like polyurethane, polyethylene, butyl rubber, petrolatum and combinations thereof, DEKOTEC is able to offer a broad variety of proven corrosion prevention systems as well as tailor made solutions for special fields of application.



DEKOTEC GmbH
Felderstraße 24,
51371 Leverkusen, Germany

**Major Products**

- BUTYLEN tapes and systems
- DEKOMAT wrapping machines for BUTYLEN-Tapes
- LIQUITOL polyurethane coatings
- Plastelen tapes and mastics
- DEKOTEC Heat Shrink Sleeves
- Bitumen tapes
- DEKOTEC Rockshield DRM-PP



For enquiries, please contact

BSS Technologies
Plot No: TP010524,
National Industries Park, Jebel Ali
Tel : + 971 4886 7015
Fax : +971 4886 7013
Email : dekotec@bsstechnologies.com

www.bsstechnologies.com

1119R11

ATMOS

INTERNATIONAL

ATMOS International Ltd
St Paul's, 781 Wilmslow Road,
Manchester, M20 2RW, UK



For enquiries, please contact

BSS Technologies

Plot No: TP010524,
National Industries Park, Jebel Ali
Tel : + 971 4886 7015
Fax : +971 4886 7013
Email : atmos@bsstechnologies.com

ATMOS INTERNATIONAL

Atmos International (Atmos) provides pipeline leak detection and simulation technology to the oil, gas, water, and associated industries. The company was founded in 1995 in the UK by the inventor of the statistical pipeline leak detection system – Atmos Pipe, now one of a suite of leak and theft detection solutions from Atmos. These technologies are implemented on hundreds of pipelines in over 50 countries, including major oil and gas companies such as Shell, BP, ExxonMobil, and Total.

Major activities include

- Statistical Pipeline Leak Detection and Location
- Rarefaction Wave Leak Detection and Location
- Model based Pipeline Leak Detection and Location
- Non-intrusive Instrumentation for Leak and Theft Detection
- Airport Hydrant Leak Detection
- Theft Detection System
- Online and Offline Hydraulic Simulation
- Batch Tracking
- Pig or Scraper Tracking
- Operator Training Simulator
- Gas Management System
- Tank Farm Management
- Maintenance



SAFETRACK BAAVHAMMAR AB

Safetrack provides the Cathodic Protection, Ground Circuit and Railway Industry with modern technologies for connecting cables to steel structure.

The Pinbrazing method were improved dramatically by Safetrack when the patented electronic (Constant Energy) were invented. Later the highly appreciated new S4 Automatic brazing gun were developed and fast become the only demanded gun at many users. The gun make sure to minimize any operator failure and brazing is used to ensure a safe electrical connection to different types of steel structures. The pin brazing method is the perfect method to use in cathodic protection systems for application of jumper bonds on pipes, connection of measuring cables, installation of sacrificial anodes, test posts and grounding installations. Using pin brazing for connecting bracelet anodes on pipe laying vessels (lay barges and reel barges) is the safest and quickest method which ensure high performance of the pipelaying.

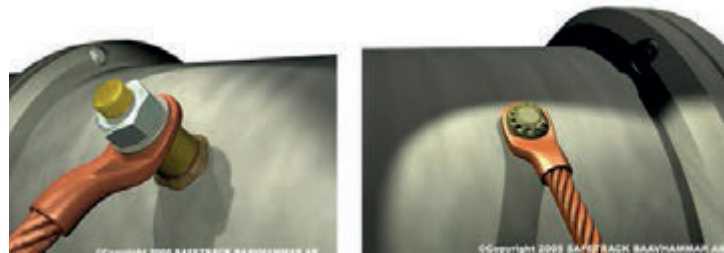
**Safetrack Baavhammar AB**

Möllebergavägen 339-24,
245 93 Staffanstorp, SWEDEN

**The great benefits with Pinbrazing:**

- Works in any weather condition, even rain and snow!
- Fast, a complete bond takes 1-2 minutes
- Can be used in all angles
- Ideal for pipelaying vessels
- Economical
- Safe for the operator
- Low temperature, much less than thermit welding
Safe for the material as it does not melt the work material down.



For enquiries, please contact

BSS Technologies

Plot No: TP010524,
National Industries Park, Jebel Ali
Tel : + 971 4886 7015
Fax : +971 4886 7013
Email : safetrack@bsstechnologies.com

www.bsstechnologies.com

BARTHAUER



Barthauer Software GmbH

Software for geoinformatics and water management
 Head Office Braunschweig
 Pillaustraße 1a
 38126 Braunschweig



For enquiries, please contact

BSS Technologies

Plot No: TP010524,
 National Industries Park, Jebel Ali
 Tel : + 971 4886 7015
 Fax : +971 4886 7013
 Email : barthauer@bsstechnologies.com

www.bsstechnologies.com

1119R11

BARTHAUER SOFTWARE GmbH

Barthauer Software GmbH is a medium-sized company that has been operating in the German-speaking regions of Europe for over 25 years. More than 1,000 customers are now using "Barthauer software". About 40 employees are dedicated to the maintenance, development and support of the company's leading product, the database-driven pipeline management system BaSYS.

Our motivation is the fair allocation and conservation of resources. We make information available over generations. We support our customers in the responsible use of scarce resources through infrastructure information solutions.

Modeling and efficient design of individual information systems for geoinfrastructures - Software for design, operation and management of supply and disposal networks.

With comprehensive functionality, flexibility, and practical benefits – especially in the water and waste water segments – the professional and efficient pipeline management system is used for infrastructure planning by civil engineers, the employees of special purpose associations, municipal organisations and public services.

Through its "multi-platform concept", the company offers integration with the GIS/CAD systems of leading global manufactures such as Autodesk, ESRI, Intergraph and Bentley via a uniform user interface. With MS SQL Server or Oracle, Barthauer offers its customers a choice of two database management systems.

In conjunction with the waste water workgroup formed by the German state building authorities, Barthauer has been developing and implementing the current, "original" ISYBAU interfaces for comprehensive transfers of technical sewer data between customers and vendors since 1991.

- BaSYS covers all aspects of supply or removal network lifecycle
- Powerful network planning and design functions
- Common GUI for all major CAD / GIS platforms (ArcGIS, ACAD, Bentley Microstation, Intergraph Geomedia)
- Asset registry
- Condition control and assessment
- Rehabilitation planning
- Asset evaluation, amortization
- Hydraulic masterplan
- Operation and maintenance



JPAC TECHNOLOGIES PVT. LTD.

JPAC Technologies Pvt. Ltd. Along with its flagship solution "Pipeline Construction Management System" has been serving the Oil and Gas Pipeline industry. PCMS is an affordable, easy-to-use solution that integrates planning, GIS, construction, documentation and asset management into one program with a built-in interface to enter and retrieve information. Location and Status of each Pipe and Fitting gives the answers to when and where.

The system is designed to help you remember every single line item, right down to the last nail. Using a proven dynamic query generation method that's much faster than a traditional spreadsheet, PCMS draws from an extensive database of field data. Its flexible reports provide you with a number of ways to analyze construction progress linked with work procedures and material certificates.

Work smarter and faster with better document control and improved collaboration between clients, vendors, subcontractors and consultants. Our comprehensive features will enable you to track, monitor, analyze, observe, Locate and store data and much more. Our online Project Center will capture essential document information, making business processes more efficient and effective.

Since PCMS is web-based software it provides a lot more benefits than traditional software, such as, on demand accessibility, fast setup, quick customization requests etc.

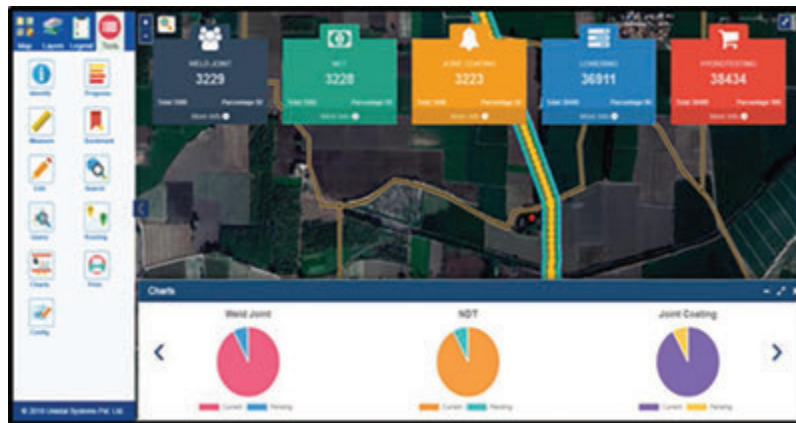
**The Major areas of Specialization**

- Pipeline Construction Management System
- Document Tracking & Completions
- Pipe & Material Tracking
- Network Planning
- Construction Management
- Asset Management
- Customer Mapping
- Safety & Outage Management
- Field Survey & Mapping
- Infrastructure Management Solution
- Web GIS Solutions and Services
- Remote Sensing and Photogrammetry

SALIENT FEATURES

- Hosted Application
- Pipe Tracking using BarCode
- Field Entry From Handhelds
- Handheld App with BarCode
- Instant Report Generation
- Report Approval System
- Generation of PipeBook
- Generation of Progress
- View Color Coded Activities
- Assets with Attributes
- Cut Pipe Nomenclature
- Linked Quality Reports
- Linked NDT Films
- Inbuilt Report QC
- Mechanical Completion
- Completions Management



JPAC Technologies Pvt. Ltd.
 # 404, C-Wing, Eastern Court
 Parleshwar Road, Vile Parle (East)
 Mumbai - 400 057, INDIA.



For enquiries, please contact

BSS Technologies
 Plot No: TP010524,
 National Industries Park, Jebel Ali
 Tel : + 971 4886 7015
 Fax : +971 4886 7013
 Email : jpac@bsstechnologies.com

www.bsstechnologies.com



IGP Engineers Private Limited

79, Valmiki Street, Thiruvanniyur,
Chennai - 600 041

MONOLITHIC INSULATION JOINTS



For enquiries, please contact

BSS Technologies

Plot No: TP010524,
National Industries Park, Jebel Ali
Tel : + 971 4886 7015
Fax : +971 4886 7013
Email : igp@bsstechnologies.com

www.bsstechnologies.com

1119R11

IGP ENGINEERS PRIVATE LIMITED

From a modest beginning in 1955, IGP group today provides over 55 products and services to the core sector. The group's products are well accepted in domestic and international markets.

IGP R&D team interacts with universities and technical associates to design new products. These products and processes are developed using in-house facilities.

IGP group has established long term relationship with its customers through custom designed world class products and services.

IGP is Asia's leading Gaskets Manufacturer. Apart from Gaskets, Monolithic Insulation Joints are developed & manufactured in-house at IGP-Unit 2 facilities since 2002.

Monolithic Insulation Joints

- Are boltless, rigid pipeline components, factory welded and ready for installation at site.
- Provides electrical resistance between the pipeline sections and adjoining structures, thus improving the effectiveness of the Cathodic Protection System (CP pipeline).
- Suitable for underground and above ground installations.
- Maintenance free – fit & forget.

Benefits:

- Eliminates electrical short circuits and stops stray current in pipeline systems.
- Most economical and reliable method that can be used for cathodic protection in all applications of the pipeline systems.
- Eliminates field assembly of bulky installations of Flanges, Gasket Kits with bolt & fasteners.

Mechanical Properties:

- The excellent mechanical properties are achieved by a rigid design of statically favourable form, using the thermos-setting plastic free from clod flow as insulating material.
- The welded unit provides safe and reliable connection even over extremely long period of operations without risk of the secured and locked unit losing or separating.
- The Joints have undergone all types of pressure tests requirements as per media of the fluid or application of the pipeline design adhering to the international standards & testing requirements or customer special requirements at our works facilities.

Electrical Properties:

- The dimensioning and practical arrangement of the insulating sections within the overall design in addition to technical production factors, in conjunction with insulation materials of a suitable quality, result in the ideal overall electrical behavior of the insulating joints large external insulating length, thus eliminating the possibility of spark over.
- Very good dielectric strength, substantially greater than conventional insulating flanges.

Quality Control:

- We are performing all pressure tests in-house, like Hydro, Pneumatic, Fatigue, Combined Cycle, Bent, Torsion, NACL Immersion, insulation resistance, Die-electric strength, adhesion and Holiday Tests.

Data Required for Manufacturing:

Pipeline application (fluid details), details of pipeline material, size, schedules, Design pressure and temperature.

HEATH CONSULTANTS INCORPORATED

Heath is a manufacturer that provides products and services for the utility protection, asset management and damage prevention markets. Our core focus is leak detection for the natural gas industry. We strive to keep up with ever-changing market demands to provide state-of-the-art services and products to each of our customers.

Heath Consultants has been a trusted name since 1933 as the leading provider of leak detection services and products to the midstream, upstream and downstream marketplaces.

Since our inception Heath's highly qualified and experienced management team provides a strong direction that focuses on customer service and satisfaction. We have an excellent track record with utilities throughout the United States and abroad.



Proven Products & Advanced Technologies

- Heath Volume corrector (HVC)
- Heath Data Recorder (HDR)
- Heath Chart Recorder (HCR)
- Remote Emissions Monitor(RMLD-REM)
- Optical Methane Detector (OMD™)
- Remote Methane Leak Detector-Intrinsically Safe (RMLD-IS™)
- Advanced mobile survey
- Detecto Pak-Infrared (DP-IR™)
- Flame Ionization (FI)
- Mobile Kits
- Sure-Lock® (Pipe & Cable locator)
- Plunger Bars & Other Support Tools
- ODARATOR 2™
- EI - 5 Ethane Identifier



Heath Consultants Incorporated

9030 Monroe Road
Houston, Texas 77061 USA

*Leading product manufacturer for the
Utility Protection, Asset Management &
Damage Prevention*



For enquiries, please contact

BSS Technologies

Plot No: TP010524,
National Industries Park, Jebel Ali
Tel: +971 4 8867015
Fax: +971 4 8867013

Email: heathconsultants@bsstechnologies.com

www.bsstechnologies.com

1119R11

ASSOCIATES

Magnetic Pumping SOLUTIONS

Magnetic Pumping Solutions

The Dene, Ropley,
Alresford SO24 0BG, United Kingdom

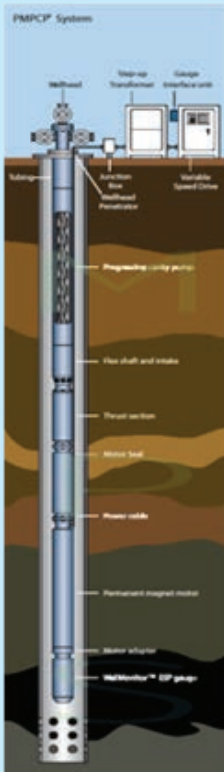

PERMANENT MAGNET MOTOR DRIVEN ESP / PCP SYSTEMS

For enquiries, please contact

BSS Technologies

Plot No: TP010524,
National Industries Park, Jebel Ali
Tel : + 971 4886 7015
Fax : +971 4886 7013
Email : magnetic@bsstechnologies.com

www.bsstechnologies.com

1119R11

MAGNETIC PUMPING SOLUTIONS

Magnetic Pumping Solutions is a privately owned US company that develops, manufactures, tests, installs and services permanent magnet motor driven artificial lift systems. All engineering and development work is carried out in the UK. The company has installed centrifugal pumps (ESP) running on permanent magnet motors, referred to as PMESP® and Progressive Cavity pumps referred to as PMPCP® for use in oilfield applications. Systems have been deployed and are presently operating in the USA, Europe, Middle East and Asia.

Permanent Magnet Motor Driven Downhole Pumping Systems

20 - 2000 HP Rating

10 to 60,000 BPD Flow Range

50 - 6000 RPM Speed Range for driving ESPs and PCPs

Benefits:

- High Efficiency compared to Induction Motors, In excess of 95%
- Green Technology with 20 to 75% power saving from existing technology
- Shorter and Cooler running systems that enhance Reliability and Run-Life
- Improved ESP and PCP performance in wells with High GOR or Slug Flow
- Advanced Gas handling capabilities with special automated algorithms
- Single section PM motors with no tandem connections
- Potentially one size smaller Cable and smaller transformer providing added cost saving and smaller footprint.

Applications

- High productivity wells where run life and performance of the pumping system is Critical
- Gassy wells
- Wells with low producing fluid rates
- Wells in which an ESP system may be installed below the perforations
- Wells with high bottom hole temperatures and scale issues
- High HP wells where the power saving is a significant factor
- High dogleg severity applications
- Fields with high cost electrical power or limited power availability

PM Control - PMVSD®

- The Permanent Magnet Motor and the special Variable Speed Drive (PMVSD®) are the core components of the MPS PM driven artificial lift systems.
- To reach the maximum efficiency while operating a PMM, the surface control logic in the PMVSD® will always be tracking the actual position of the rotor in the downhole motor to ensure that the stator magnetic field controlled by the PMVSD® is maintained at the optimum levels with respect to the rotor magnetic flux generated by the permanent magnets.
- MPS is applying a proprietary control technique to always maximize motor efficiency and generated torque at various operating conditions.

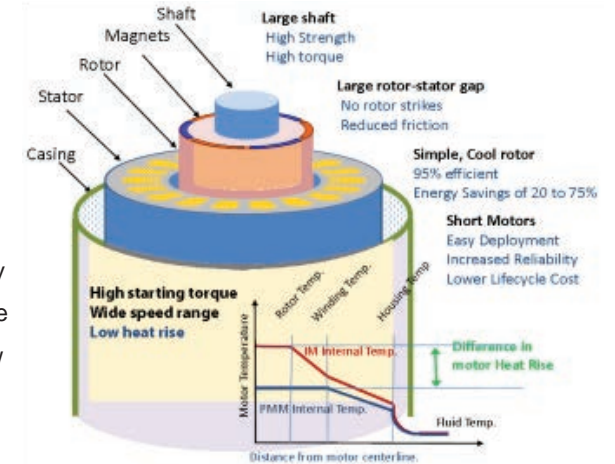

OXFORD MONITORING SOLUTIONS

Oxford Monitoring Solutions designs, manufactures and installs down hole, surface and remote monitoring solutions for the oilfield artificial lift industry. Our solutions are reliable, easy to understand and easy to implement in the field. We specialize in monitoring and control solutions for electric submersible pump (ESP), progressive cavity pump (PCP), rod pump (RP) and jet pump (JP) applications with a product offering spanning simple pump-off control gauges through to complete field automation solutions with remote web based monitoring.

Product Range

- ESP Gauge Systems
- Downhole Permanent Gauge Systems
- Downhole Gauges for PCP, Gas Lift, Jet Pumps and other artificial lift systems
- Surface Monitoring Systems
- Real Time SCADA Solutions

Features:

- Wide range of products enabling a fit for purpose selection of gauge systems
- Wide operating temperature range (up to 175 °C maximum operating temperature)
- Modern electronic components, screened and tested individually for high reliability and performance with advanced gauge layout and design.
- Gauge performance and run life tracking for extended utilization
- Capable of measuring up to 12 downhole parameters with multiple motor temperature and pressure measurements.
- Plug and Play design with no requirement of field programming or calibration
- Value engineered product that provides high performance with attractive prices

Applications

- All oil producing wells
- Naturally Flowing wells
- Monitoring or exploratory wells
- Wells with Artificial Lift Systems
- Water Wells
- Gas Wells including CBM wells
- Fields requiring real time monitoring and automation (Digital Oilfield)

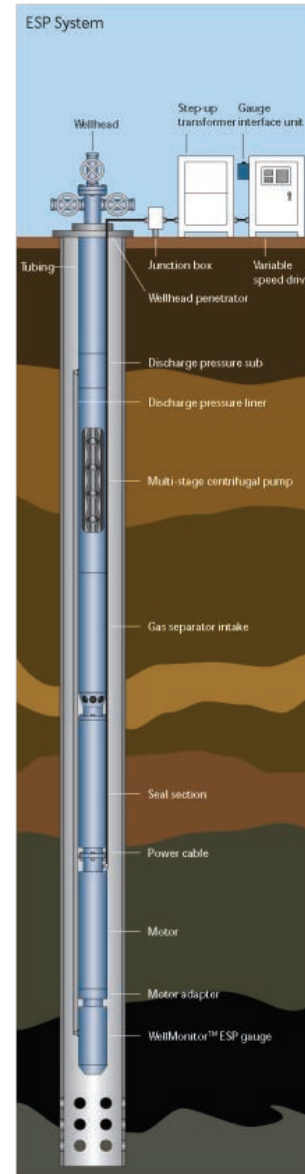

Oxford Monitoring
SOLUTIONS

Oxford Monitoring Solutions

Oakfield Industrial Estate,
Eynsham OX29 4TH, United Kingdom

ASSOCIATES

DOWNHOLE MONITORING SYSTEMS



For enquiries, please contact

BSS Technologies

Plot No: TP010524,
National Industries Park, Jebel Ali
Tel : + 971 4886 7015
Fax : +971 4886 7013
Email : oxford@bsstechnologies.com

www.bsstechnologies.com



Thermopads

Thermopads Pvt Ltd

28, Nagarjuna Hills, Punjagutta,
Hyderabad - 500 082, INDIA



For enquiries, please contact

BSS Technologies

Plot No: TP010524,
National Industries Park, Jebel Ali
Tel : + 971 4886 7015
Fax : +971 4886 7013
Email : thermopads@bsstechnologies.com

THEMOPADS PVT LTD

Thermopads is a multi-product, multi-service organization – one stop destination for all heating needs – with sales service points covering every part of India and overseas branches in U.K, Germany, Singapore and U.S.A. The array of company's products have applications in almost all industries – Petroleum, Power Plants, Metallurgical, Cement, Fertilizers, Textiles, Food and confectionery, Parma, Paints, Edible oils, etc.

Thermopads manufactures/provides – Surface/immersion electrical heating equipments suited to hazardous and non-hazardous environments.

Thermopads are leading manufacturers of heat tracing and heating cables in the world.

Electric Heat Tracers are specialized heating cables with low watt density for applications.

- To maintain temperature of fluids in pipelines at elevated temperatures for ease of handling, storage and transfer
- To heat-up process fluids in pipelines/tanks/equipment.

Electric Surface Heating:

The main principle of ESH is that heat is applied to the exterior surface vessels/equipment being heated.

Thermotrace –HTT: Power limiting tracers, Cut to required length at site and in wide range of wattages. These Tracers are ATEX certified

Thermotrace – CTL: Constant output, parallel circuit type, cut to required length at site and in wide range of wattages.

Self-Limiting Self Regulating Tracer – STP: Self-Limiting & Self-Regulating (SLSR) with variable output, temperature dependent, parallel circuit type, cut to required length at site and in a wide range of wattages. These Tracers are ATEX certified.

Heating Cables – HC: Constant output, Series circuit type, heating cables insulated with PTFE, metal braided if required, outer PVC or insulation combinations for use in both process heating and freeze protection applications. These Tracers are ATEX Certified.

Heated Hose: This product finds application in Gas analyzer sampling, Hot melt transfer in Petroleum, Chemical, Glue, Paint, Food processing etc. where in the product inside the process tube (part of heated hose) needs to be maintained at critical temperatures to avoid condensation / solidification of the gas or temperature drop in the fluid.

Floor Heating Cables & Mats: These are constant output, Series circuit type heating cables/mats for floor heating applications in homes/offices, driveways, green houses in cold countries / places.

Salient features :

- Simple
- Economical and Reliable
- Uniform Heating
- No Corrosion Problems
- Low capital and running costs
- Maintenance free
- Ease of handling
- Precise temperature control

ELMED DR. ING. MENSE GMBH

ELMED specialises in the design and manufacture of measuring and testing equipment. For over 60 years customers in many technical fields have been relying on this family-owned company. The ISOTEST product range is a handy tool in the detection of coating defects and offers a reliable solution to corrosion protection within the framework of quality control. By means of high voltage impulses coatings on a conductive basis can be gently NDT-tested. This method spots even the tiniest defects that are often missed during the normal visual inspection. Further advantages of the ISOTEST: testing with reserves of energy, guarantee of stability of selected test voltages, testing even on dirty or damp surfaces, very flexible at use thanks to numerous accessories.

**ELMED Dr. Ing. Mense GmbH**

Weilenburgstr. 39
42579 Heiligenhaus, Germany

**Products**

- ISOTEST inspect 35
- ISOTEST inspect 8.0
- ISOTEST 4S
- ISOTEST 4S plus
- ISOTEST HV

For enquiries, please contact

BSS Technologies

Plot No: TP010524,
National Industries Park, Jebel Ali
Tel : + 971 4886 7015
Fax : +971 4886 7013
Email : elmed@bsstechnologies.com

www.bsstechnologies.com



VP Engineers

79, Valmiki Street, Thiruvanniyur,
Chennai - 600 041



PIPELINE CLEANING PIGS

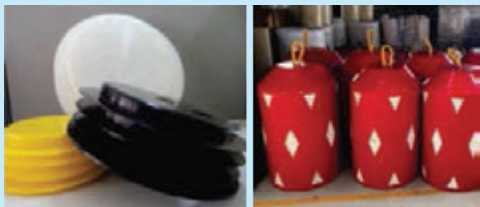

PIPE END PROTECTOR FOAM PIGS



CASING INSULATOR & END SEAL

For enquiries, please contact

BSS Technologies

Plot No: TP010524,
National Industries Park, Jebel Ali
Tel : + 971 4886 7015
Fax : +971 4886 7013
Email : vp.eng@bsstechnologies.com

www.bsstechnologies.com

1119R11

VP ENGINEERS

VP Engineers AN ISO-9001:2015 Certified organization has a manufacturing unit near Chennai and evolved as an Engineering Enterprise picking the art of manufacturing products using different manufacturing processes with materials like Poly Urethane, Plastic, Rubber & specialized Metal (Ferrous & Non ferrous, SS, etc).

VP ENGINEERS uses the following materials in the production

- Poly Urethane – Poly Urethane Cast & foam varieties, FRP, natural rubber, NBR, Neoprene, Viton.
- Metals – Ferrous & Non- Ferrous like Carbon & Stainless Steel, Copper Alloys, Nickel Alloys, etc.
- Plastics – PP, HPDE, LDPE, Polyamide 6,66 (Nylon), POM (Poly Acetal), ABS, PTFE, etc

Pipeline PIGS & CASING INSULATORS – END SEAL

VP ENGINEERS manufacturers Pigs in Various types, Sizes to suit end application, made out of PU/ NBR.

- Bidirectional Pigs
- Foam Pigs
- Batching Pigs
- Cleaning & Gauging Pigs
- Decoking Pigs

We also do Casing Insulator & Casing End Seal used in Oil/Gas/ Water Pipeline.

END Protectors & Insulation

To provide protection in pipe & Fittings VP Engineers manufacture following items

- Pipe fittings Caps – OD, ID Fitting & Bevel Cap
- Flange End Protector – Box type, Belt type, PTFE & Metal.
- Flange Insulation – Collar sleeve / POM Sleeve
- Bolt & Nut Protector

Cooling Tower & Strainer Nozzle

VP Engineers offers nozzles, Grids for Cooling tower, WTP/ETP, etc.



INSERTS



NOZZLES



GRIDS

TELE-FONIKA KABLE S.A

The group TELE-FONIKA Kable S.A (TF Kable) is a recognized and trusted provider of copper and aluminum cables and wires, optical fiber cables, used by the world's leading companies in Mining, Energetics, Renewable Energy, Railway industry, Automotive Industry, Telecommunication, Welding Industry, Shipbuilding Industry, Oil and Gas, Automatics. We offer a comprehensive assortment of wires and cables. Apart from the standard assortment of products, we also offer special cables made to meet individual customer orders. Our product assortment includes 25 thousand of cable types.

Types of Cables**High Voltage cables:**

- HV XLPE cable with copper wires screen and aluminium laminted foil.
- HV XLPE cable with corrugated aluminum sheath.
- HV XLPE cable with lead alloy sheath

Marine and Offshore cables

- Shipboard instrumentation, control and telecommunication cables
- MV Single-core halogen-free shipboard power cables
- MV three-core halogen-free shipboard power cables
- Shipboard power cables

Oil and Gas / Offshore

- BS66883/BS7917 (UKOOA)
- NEK606



TF Kable

Tele-Fonika Kable S.A

Hipolita Cegielskiego 1
32-400 Myslenice, Poland

Leading producer of cables & cable systems

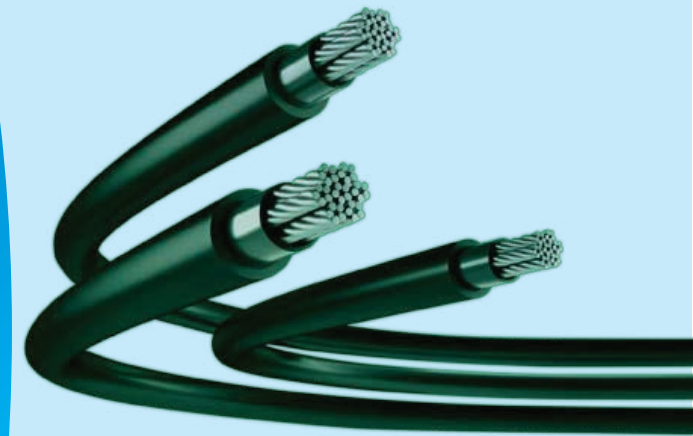

For enquiries, please contact

BSS Technologies

Plot No: TP010524,
National Industries Park, Jebel Ali
Tel : + 971 4886 7015
Fax : +971 4886 7013
Email : tfkable@bsstechnologies.com

www.bsstechnologies.com



JEF Techno Solutions Pvt. Ltd

HO: No.2, I Floor, 8TH Street,
Nandanam Extn., Chennai-600035

Lightning Protection



In-house software for Comprehensive Lightning risk assessment and design as per IS/IEC 62305.

- Evaluates all risks R1, R2, R3 & R4
- Optimises Solution
- Automatically generates tentative BOQ

Grounding



Conforming to IS 3043, BS7430,
IEEE:80 & IEC 62561

For enquiries, please contact

BSS Technologies

Plot No: TP010524,
National Industries Park, Jebel Ali
Tel : + 971 4886 7015
Fax : +971 4886 7013
Email : jeftech@bsstechnologies.com

www.bsstechnologies.com

JEF TECHNO SOLUTIONS PVT. LTD

JEF Techno Solutions Pvt. Ltd., an ISO 9001:2015 certified Company, is a pioneer in Asia in the field of EMI/EMC studies including Root Cause Analysis, Safety Audits (electrical & fire), Lightning Protection and Grounding Solutions. We have built a very strong and credible track record of providing effective and reliable solutions for issue related to grounding, lightning protection, EMI/EMC to various customers. We offer comprehensive solution for Electro-magnetic Interference & Electromagnetic Compatibility for Oil & Gas, process plants and onshore & offshore installations. We have proven expertise in AC interference study of high voltage transmission lines and buried pipelines -both safety & corrosion problems.

EMI/EMC - For Oil & Gas

- AC Interference Studies
- DC Interference Studies
- DC Stray Current Analysis
- EM Zoning, Matrix & Evaluation
- Electromagnetic Shielding
- Static & High Frequency Grounding
- Electro Magnetic Isolation

CLASSIC SIGNATURES OF EMI

- Unexplained Tripping
- Sensor/Valve Maloperation
- Process Interruptions

UNIQUE AUTOMATED SOLUTIONS -For Technical Audits

- Unmatched Accuracy
- High Reliability
- Ultimate Speed
- Transparency & Clarity
- Total Flexibility
- Consistency & Standardization

TECHNICAL SERVICES

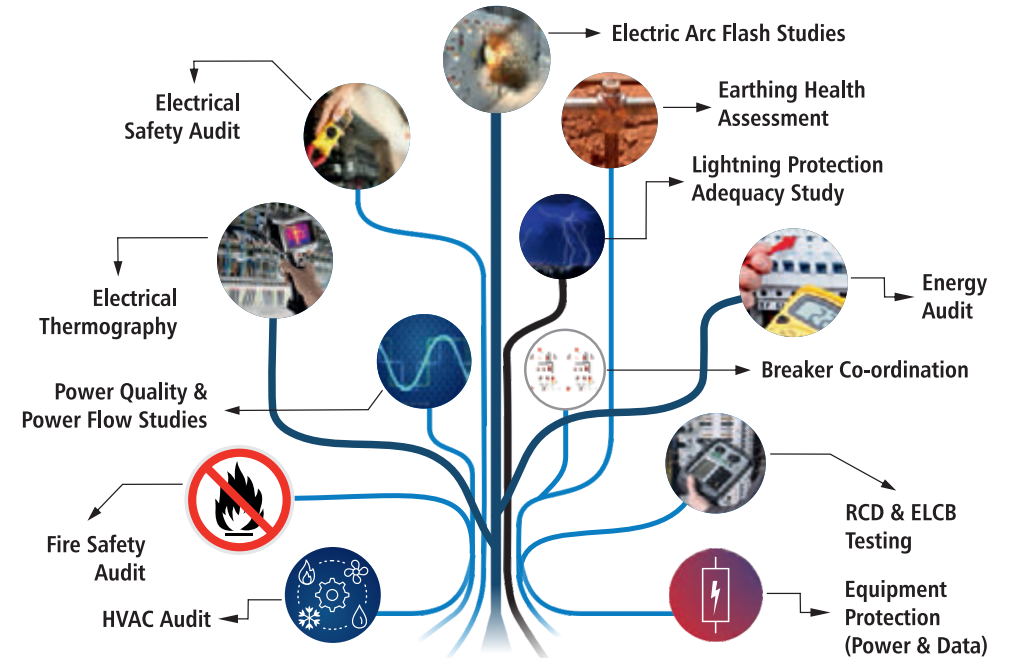

GGG OIL & GAS SYSTEMS

GGG is a fully independent system integration company / solution supplier. Specialist in design, production and implementation of complete integrated flow metering solutions for custody transfer gas and LNG projects, worldwide. GGG can also be your partner in gas filtration, pressure reduction, flow control or gas treatment installations. As part of the package GGG Oil & Gas Systems can provide turnkey flow metering systems including:

- Fully integrated metering skids
 - Flowmeters (Ultrasonic, Coriolis mass, etc)
 - Valves and piping
 - Instrumentation (Temperature, pressure, etc)
- Analyzer solutions with
 - Sampling systems
 - Analyser systems
 - Density, viscosity
 - Gas composition
 - LNG sampling systems
 - Mercury analyzer, H₂S and Total Sulphur analyzer, Oxygen analyzer
- Supervisory and flow computer systems including flow computers, control panels and customer interfaces
- Validation and calibration services

GGG follows a 360°-degree solution driven approach Total commitment; support in every phase of the project

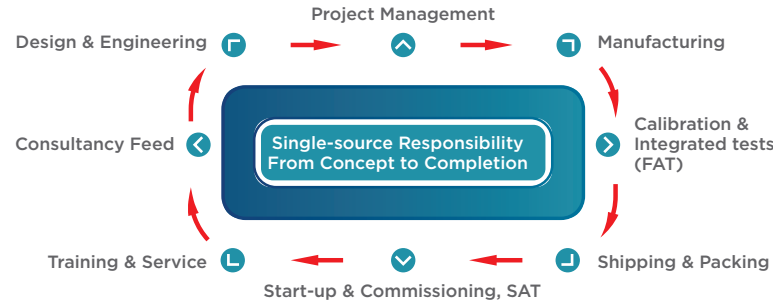

From upstream to downstream

GGG Oil & Gas Systems delivers flow metering systems for offshore and onshore locations, from platforms to (off-)loading facilities FSRU & FNLG, for pipeline operations, and refineries. We work closely with our customers to provide the most cost-effective, highest quality solutions. Every solution we deliver is a tailor made job; designed, engineered and built based on the customer's specifications and requirements, as well as international industry standards and best practices.

Turnkey solutions from concept to start-up

- Design and engineering
- Project management
- Manufacturing of complete skids
- Calibration, integrated testing, and certification
- Shipping and packing
- Start-up and commissioning, training and support

Experienced project engineering

GGG has an experienced in-house team of specialists in mechanical engineering, (flow) instrumentation, electrical engineering and process automation. (PLC, DCS/ SCADA)
From project definition to engineering and on site installation, quality assurance is the key to any project.



GGG Oil & Gas Systems
Onderzeel 6 - 2920 Kalmthout - Belgium

LNG and gas metering systems

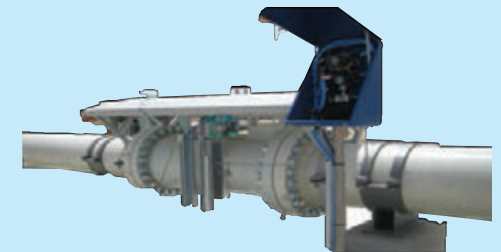

For enquiries, please contact

BSS Technologies

Plot No: TP010524,
National Industries Park, Jebel Ali
Tel : + 971 4886 7015
Fax : +971 4886 7013
Email : ggs@bsstechnologies.com

www.bsstechnologies.com

PRODUCTS

IMPRESSED CURRENT ANODES & ACCESSORIES

- Graphite Anodes
- High Silicon Iron Anodes
- Platinized Ti/Nb Anodes
- MMO Coated Titanium Anodes

GALVANIC ANODES

- Mg Anodes (High & Low potential Cast & Extruded)
- Zinc (Soil, Marine, Tank, Pier, Piling, Ribbon, Bracelet Etc)
- Aluminium (Flush Mount, Piling, Bracelet)

CATHODIC PROTECTION BACKFILL & ACCESSORIES

- Petroleum Coke Breeze Backfill
- Chemical Backfill
- Vent Pipes
- Slotted PVC Casing Pipes
- Metallic Casing Pipes etc

POWER SUPPLIES & MONITORING

- Air Cooled & Oil Cooled Transformer Rectifiers
- Pulse Rectifiers
- Remote Monitoring & Control Systems.
- Solar Power Suppliers

GROUNDING PRODUCTS

- Zinc Grounding Cells
- Zinc Mats
- Polarization Cell Replacement (Liquid and Solid state)
- Zinc Ribbon Anodes
- Grounding Backfills.

CABLE & WIRE

- HMWPE
- HMWPE-HALAR
- HMWPE-KYNAR(PVDF)
- XLPE/SWA/PVC
- XLPE/PVC
- Survey Wire etc.

CONNECTIONS & ACCESSORIES

- Cable Splice Kits & Accessories
- Coating Repair material
- Pin Brazing Equipment & Accessories
- Heat Shrink Tubes
- Thermite Weld Material

TEST STATIONS & ACCESSORIES

- Junction Boxes
- Variable Resistors
- Cathodic Protection Test Stations
- Cathodic Protection Remote Monitoring Test Stations
- Magnetic Reed Switches.
- Shunts
- Bond boxes

REFERENCE ELECTRODES & ACCESSORIES

- Coupons
- Copper/Copper Sulphate, Silver/ Silver Chloride, Zinc
- Portable & Permanent

INSTRUMENTS & ACCESSORIES

- CP Potential Meter & Equipments
- GPS Synchronized Current Interrupters
- Pipe & Cable Locators
- Survey Equipments
- Insulation Test Equipments
- Pipeline Monitoring & Analysis Equipments.
- CP Data Recorder/loggers, Soil Resistivity Measuring Equipments
- CP Test Equipments
- Portable Power Supplies
- Coating Thickness Guages

APPLICATION

Our Major Activity - Cathodic Protection – involves in all metallic structure buried / immersed in any electrolyte like Soil, Water, Concrete, etc... Structures can be like Pipelines, Tanks, Jetties, Berths, Jackets, Platforms, Reinforced Concrete, etc..

MAJOR ACTIVITIES/ SERVICES PROVIDED.

BSS Tech Offers a wide range of Activities , Surveys and Material / Equipment for the Industry's Corrosion and Cathodic Protection requirement

Few of The Major Activities We Provide are:

- Cathodic Protection System Surveys.
- Soil Resistivity Surveys.
- Cathodic Protection System Designs – in accordance to NACE Specifications & Practices, British Standard, Applicable Industry and Client Requirements.
- Risk Assessment & Consequence Studies.
- Formulation of Multilayer Rehabilitation Plans.
- Computerized Surveys – CIPS, DCVG, Pearson
- AC Mitigation Studies and Measures.
- Insulating Flange Testing.
- Interference Testing.
- Manufacturing of Corrosion Control, Corrosion Monitoring and Cathodic Protection Equipment / Materials.
- Supply and Installation of Cathodic Protection Systems.
- Testing and Commissioning of Cathodic Protection Systems.
- Remote Monitoring and Control Systems.
- Maintenance Contracts.
- Training Programs to Clients in Corrosion Related Subjects.

PRODUCT DEVELOPMENT & RESEARCH

It is BSS Tech Managements special interest that, a good percentage of our annual profit is invested wisely in the areas of Research and Developing new Products. These are spend either directly in our facilities or in close co-operation with our raw material suppliers facilities. Our Research & Product Development includes the continuous and extensive search for new materials including the applicability and behaviour of existing Material / Equipment for different electrolytes and environments. A wide variety of designs are developed In-House and selected to customer satisfaction, strictly considering the environmental conditions and Material / Equipment are selected with thorough knowledge and fully understanding the properties and behaviour of the products.

GROUP ACTIVITIES

Cathodic Protection & Corrosion Engineering

Anti Fouling

AC / DC Interference and Mitigation Study & Modelling

Coatings & Field Joints

Leak Detection System

Software for Geoinformatics and Water Management

Wireless Remote Monitoring Systems

Electrical Grounding Backfills

Holiday Detection Systems

TR Units & RMCS

Monolithic Isolation Joints

Well Head Remote Monitoring

Pipeline Construction Management System

Construction & Manufacturing

Marine Cathodic Protection

Aluminium & Zinc Casting

Calibration and Certification Services for Test and Measuring Instruments

Downhole Monitoring System

ESP Pumps of Permanent Magnet Motors

Manufacturer of Specialized Industrial Products Based on PU Castings, Foam, Injection Moulding, Blow Moulding & Services

Electric Heat Tracer

High Voltage Cables

Composite Repair Solutions

EMI / EMC Consulting, Lightning Protection & Grounding Solutions

Integrated Flow Metering Solutions for Gas

Gas Flow Measurement & Regulation

SAIT Group



ASSOCIATE / PARTNERS

AGENTS / DISTRIBUTORS

بن ساري للتقنية المتخصصة
متخصصون في أعمال التحكم في الصدأ والتآكل والوقاية الكاثودية

B.S.S. Technologies

Specialized in Corrosion Control & Cathodic Protection

A SAIT GROUP COMPANY

www.bsstechnologies.com



Corporate Office

P.O. Box : 33464, Abu Dhabi - U.A.E.
Tel.: +971 2 446 0700
Fax: +971 2 446 0800

Head Office and Factory

P.O. Box : 52455, Dubai - U.A.E.
Tel.: +971 4 886 7015
Fax: +971 4 886 7013

SAIT GROUP OF COMPANIES

- ▲ BSS Technologies - Abu Dhabi
- ▲ BSMC - Dubai
- ▲ SSEC - Abu Dhabi
- ▲ KAZ - Saudi Arabia
- ▲ SSE Tech Kuwait W.L.L - Kuwait
- ▲ SSE Tech - Kochi, India
- ▲ RACE Tech - Mumbai, India
- ▲ BSS Tech CP (I) PVT LTD - India
- ▲ BSS Technologies FZE - Nigeria
- ▲ BSS Tech - Canada
- ▲ BSS Tech CP (INTL) SDN. BHD - Malaysia

- ▲ Own Offices
- Satellite Offices



www.bsstechnologies.com
www.corrosion.ae
bsstech@bsstechnologies.com

